

PL512/PL506

Modular Power Supply System

Technical Manual

General Remarks

The only purpose of this manual is a description of the product. It must not be interpreted as a declaration of conformity for this product including the product and software.

W-IE-Ne-R revises this product and manual without notice. Differences of the description in manual and product are possible.

W-IE-Ne-R excludes completely any liability for loss of profits, loss of business, loss of use or data, interrupt of business, or for indirect, special incidental, or consequential damages of any kind, even if **W-IE-Ne-R** has been advised of the possibility of such damages arising from any defect or error in this manual or product.

Any use of the product which may influence health of human beings requires the express written permission of **W-IE-Ne-R**.

Products mentioned in this manual are mentioned for identification purposes only. Product names appearing in this manual may or may not be registered trademarks or copyrights of their respective companies.

No part of this product, including the product and the software may be reproduced, transmitted, transcribed, stored in a retrieval system, or translated into any language in any form by any means with the express written permission of **W-IE-Ne-R**.

Control Cabinet

In the context of this user manual, the control cabinet must fulfill the requirements on fire-protective enclosures according to EN 60950 / IEC 60950 / UL 60950.

All devices are intended for operation in control cabinets or in closed areas. The LAN connection and all wire connections between the different system parts must be done via shielded cable with conductive connector shells, which are fixed with screws.

Furthermore, an additional fire-protective enclosure is required which must not affect proper air circulation.

Mains Voltage and Connection

The Power supplies are equipped with a "World"- mains input (rated voltage range: 100-240 VAC, frequency: 50-60 Hz, rated current: 16 A). Before connecting to the mains please double-check correspondence.

The mains input connection at the power supply side is described in chapter 2.1 (AC Mains Connection) at page 2.

Safety

After connecting the Power box to the mains, the mains input module is powered permanently. Filter and storage capacitors of the power factor correction module are charged with about **400VDC**. Any DC-On-Signal as well as a power switch at control board (if any installed) operates as a low voltage DC on/off switch only and not as a mains breaker. **Therefore it becomes dangerous if the box cover is open. In this case a lot of components on high voltage potential get touchable!**



Before starting any kind of work inside the power box remove the unit from mains and wait a couple of minutes with your activities! Discharge the primary DC filter-capacitors by use of a well insulated 22 ohm 10W resistor. We recommend in case of any malfunction to send the power box to Wiener or to one of our representative for service

Declaration of Conformity

Low Voltage Directive 73/23/EEC and EMC Directive Art. 10.1 of 89/336/EEC

W-IE-NE-R

Plein & Baus GmbH

declare under our own responsibility that the product

PL5 / PL6, F8-12

**Items: 0P00.xxxx; 0P01.xxxx; 0P04.xxxx; 0M11.xxxx;
0M21.xxxx**

is in accordance with the following standards or standardized documents:

- | | | |
|-----------|--|--|
| 1. | EN 60 950-1:2001
+ Corr:2004-09 | Niederspannungsrichtlinie [low voltage directive] |
| 2. | EN 61 000-6-3:2001
EN 55 022:1998
+ Corr:2001 + A1:2000 Kl. B
EN 55 022:1998
+ Corr:2001 + A1:2000 Kl. B
EN 61 000-3-2:2001
EN 61 000-3-3:1995 +Corr:1997 +A1:2001 | Störaussendung EMA [RF emission]
Störspannung [conducted noise]
Störfeldstärke [radiated noise]
Oberschwingungen [harmonics]
Spannungsschwankungen [flicker] |
| 3. | EN 61 000-6-2:2001
EN 61 000-4-6:1996 + A1:2001
EN 61 000-4-3:1996 + A1:1998 + A2:2001

EN 61 000-4-4:1995 + A1:2001
EN 61 000-4-5:1995 + A1:2001
EN 61 000-4-11:1994 + A1:2000

EN 61 000-4-2:1995 + A1:1998 + A2:2001 | Störfestigkeit EMB [immunity]
HF-Einströmung [injected HF currents]
HF-Felder [radiated HF fields] incl.
"900MHz"
Burst
Surge
Spannungs-Variationen [voltage variations]
ESD |

Conditions:

This unit is not a final product and is foreseen for use inside a closed cabinet. The supplying of loads over long distances (>3m) needs possibly additional RF rejection hardware to get in conformity of the definition. Admitted for powering by all mains.

Name and signature of authorized person

Place and Date

Juergen Baus

Techn. Director

Aug. 2006

Contents

General Remarks.....	i
Declaration of Conformity.....	ii
1 General Information.....	1
2 PL512/PL506 Power Box.....	2
2.1 AC Mains Connection.....	2
2.2 Main Switch.....	3
2.3 USB Connector.....	3
2.4 Ethernet Connector.....	3
2.5 Water Cooling Connection (Optional).....	3
2.6 Global Reset Input (Optional).....	4
2.7 Channel-Wise Interlock Input (Optional).....	5
2.8 Global Stop and Start Inputs (Optional).....	5
2.9 Alphanumeric Display (Optional).....	6
2.9.1 LED Description.....	7
2.9.2 Function of the Switches.....	7
2.9.3 Main Operating Modes and Associated Submenus.....	8
2.10 Power Output and Sense Connections PL512.....	9
2.11 Power Output and Sense Connections PL506.....	10
3 PL512/PL506 Control and Setup via USB.....	10
3.1 Installation.....	11
3.2 The Main Window.....	12
3.3 Description of the Menu Items.....	12
3.3.1 Read Power Supply Data From File Dialog.....	13
3.3.2 Output Configuration Dialog.....	13
3.3.3 Global and Network Configuration Dialog.....	15
4 PL-506/512 Wiring and First Use Instructions	16
4.1 Power Bins PBN506/PBN512.....	16
4.2 Sense Connections / Mode.....	16
4.3 Load Connections.....	17
4.4 MUSEControl.....	18
5 Web Server.....	21
6 SNMP Control.....	21
7 OPC Server.....	30
8 Power Bins PBN506/PBN512.....	31
Appendix A: Data Sheet.....	33
Appendix B: Ordering Information.....	36
Appendix C: SNMP OID Tree.....	37
Appendix D: Parallel Connection of Output Channels.....	40

Figures

Figure 2.1: PL512/PL506 Front Side with Interlock and Water-Cooled Option.....	2
Figure 2.2: PL512/PL506 Front Side with Display Option.....	2
Figure 2.3: PL512 Rear Side (Power Output Connections).....	9
Figure 2.4: PL506 Rear Side (Power Output Connections).....	10
Figure 2.5: PL512 Rear Side (Power Output Connections).....	10
Figure 7.1: PBN512 -3U RATO Power Bin.....	17
Figure 7.2: PBN506 -3U RASO Power Bin (with PL506 Power Supply inserted).....	18
Figure 7.3: Current Bar Dimensions.....	26
Figure 7.4: Two Channels Parallel.....	28
Figure 7.5: Three Channels Parallel.....	28
Figure 7.6: Four Channels Parallel.....	28

Tables

Table 1: AC Mains Input Connector Pin Assignment.....	2
Table 2: USB Connector Pin Assignment.....	3
Table 3: Ethernet Connector Pin Assignment.....	3
Table 4: Global Reset Connector Pin Assignment.....	4
Table 5: Channel-Wise Interlock Connector Pin Assignment.....	5
Table 6: Sense Connector Pin Assignment.....	9

1 General Information

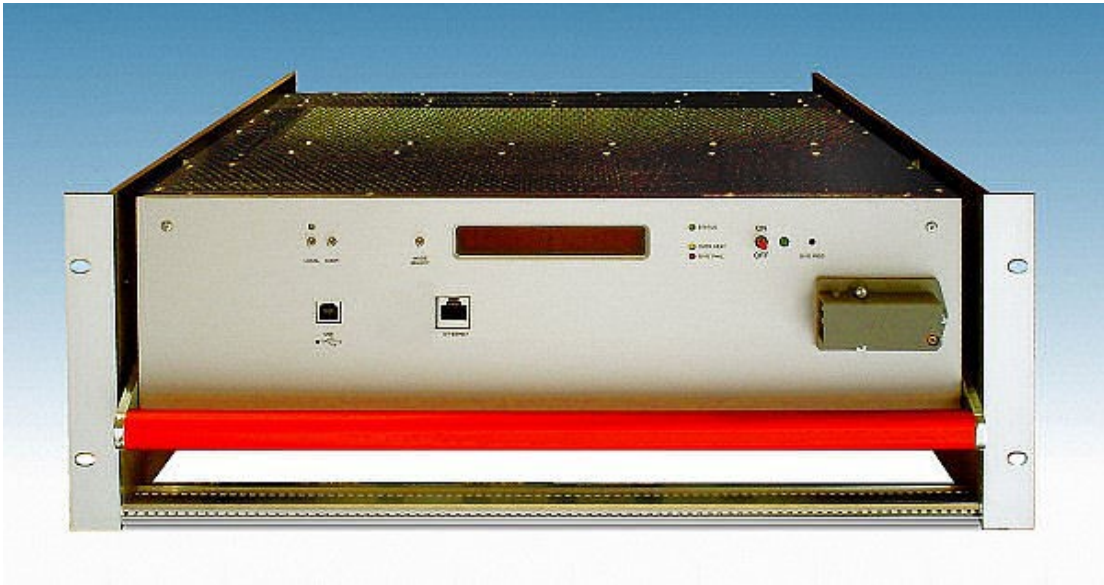

Features

- up to 12 independent processor controlled, potential free outputs
- up to 3 kW DC output power
- Programmable output voltage, current limit and rise/fall time
- Measurement of output voltages and current
- Fully controlled, programmable trip thresholds (min./max. sense voltage, max terminal voltage, max. current, power, temperature)
- PC-Control (connected to USB) with free available software
- Ethernet connection IEEE 802.3 10BASE-T and IEEE 802.3u 100BASE-TX
- WWW-Server integrated, full control via SNMP protocol
- OPC server available
- Three different voltage regulation modes programmable: Fast – Moderate - Slow
- Extremely low noise and ripple
- CE conform EN 50 081/82 part 2 or 1, safety in accordance with EN 60 950
- Sinusoidal mains current EN 61000-3-2
- Optional alphanumeric display
- Optional global interlock
- Optional channel-wise interlock
- Optional direct water cooling
- Optional *Power Bin*: Exchange of the power box without disconnecting the cabling to the load

2 PL512/PL506 Power Box

The PL512/PL506 front appearance differs slightly, depending on the existing options.



Figure 2.1: PL512/PL506 Front Side with Interlock and Water-Cooled Option



Figure 2.2: PL512/PL506 Front Side with Display Option

2.1 AC Mains Connection

The AC input connections are made with the Hirschmann connector series ST.

We recommend the mating cable plug STAK3N with the locking retainer STASI3.

AC Input	Pin	Signal	Comment
	1	Phase	Cable wire color: black or brown wire
	2	Return, Neutral	Cable wire color: blue
	3	unused	
	Earth	Protective Earth	Safety Ground, Cable wire color: green / yellow

Table 1: AC Mains Input Connector Pin Assignment

2.2 Main Switch

The green illuminated rocker switch works as a global inhibit input.

- 0 Power outputs disabled
- 1 Switch is lighting, power outputs may be enabled by the remote control.

This switch is a logic switch only. It does not disconnect the mains supply.

With the *Alphanumeric Display Option* the switch is omitted.

2.3 USB Connector

USB Socket	Pin	Signal	Comment
	1	VCC	
	2	D-	
	3	D+	
	4	GND	

Table 2: USB Connector Pin Assignment

This is the standard USB connector type B.

2.4 Ethernet Connector

RJ45 Socket	Pin	Signal	Comment
	1	TX+	
	2	TX-	
	3	RX+	
	4	GND 1	
	5	GND 1	
	6	RX-	
	7	GND 2	
	8	GND 2	

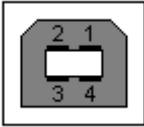
Table 3: Ethernet Connector Pin Assignment

This is the standard NIC configuration. **You need a 1:1-cable** to connect a to a HUB, or a **cross-over cable to connect to** another NIC (e.g. a **computer**). *There is no automatic signal crossing like with some routers.*

2.5 Water Cooling Connection (Optional)

The water connections are made with quick couplings series LC 6.4 mm from *Colder Products Company* (CPC). We recommend an elbow mating plug with shutoff, e.g. LCD230-04.

Consider that water inlet and water outlet are **not** exchangeable.



The safety valve may not be readjusted by the customer.

2.6 Global Reset Input (Optional)

The global reset input (POWER_INHIBIT) is provided to force all outputs to be switched off.

- connected to GND Power outputs disabled
- floating Power outputs may be enabled by the remote control

DSUB25 female	Pin	Signal	Comment
	1	NC	reserved
	14	NC	reserved
	2	NC	reserved
	15	NC	reserved
	3	NC	reserved
	16	NC	reserved
	4	NC	reserved
	17	NC	reserved
	5	NC	reserved
	18	NC	reserved
	6	NC	reserved
	19	NC	reserved
	7	NC	reserved
	20	NC	reserved
	8	NC	reserved
	21	NC	reserved
	9	NC	reserved
	22	NC	reserved
	10	NC	reserved
	23	NC	reserved
	11	NC	reserved
	24	NC	reserved
	12	NC	reserved
	25	GND	Ground of the aux. supply, connected to USB ground
	13	POWER_INHIBIT	Inhibit input

Table 4: Global Reset Connector Pin Assignment

The signals shall be connected by an isolated contact (e.g. relays), and must not be connected to other potentials.

The input has an internal 10 kΩ pull-up resistor to 5V and an input impedance of 10 kΩ.

It is possible to invert the logic of this signal by changing a jumper switch inside of the power box..

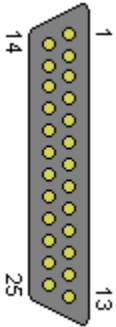
Jumper at Pin	POWER_INHIBIT Input	Functionality
1 – 2	open	power disabled (INTERLOCK)
	connected to GND	power enabled
2 – 3	open	power enabled
	connected to GND	power disabled (RESET)

2.7 Channel-Wise Interlock Input (Optional)

The channel-wise interlock inputs are provided to force a dedicated output to be switched off.

DSUB25 female	Pin	Signal	Comment
	1	Interlock U0 +	
	14	Interlock U0 -	
	2	Interlock U1 +	
	15	Interlock U1 -	
	3	Interlock U2 +	
	16	Interlock U2 -	
	4	Interlock U3 +	
	17	Interlock U3 -	
	5	Interlock U4 +	
	18	Interlock U4 -	
	6	Interlock U5 +	
	19	Interlock U5 -	
	7	Interlock U6 +	
	20	Interlock U6 -	
	8	Interlock U7 +	
	21	Interlock U7 -	
	9	Interlock U8 +	
	22	Interlock U8 -	
	10	Interlock U9 +	
	23	Interlock U9 -	
	11	Interlock U10 +	
	24	Interlock U10 -	
	12	Interlock U11 +	
	25	Interlock U11 -	
	13	reserved	

Table 5: Channel-Wise Interlock Connector Pin Assignment

Each interlock input is galvanically isolated (optocouplers). If a channel is interlocked, it is not possible to switch it on.

Signal level:

interlocked: -10 V ... +0.8 V

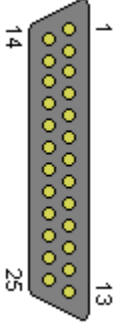
not interlocked: +2.2 V ... +10 V (input impedance 1 k Ω + LED, so higher input voltages can be used if an external resistor is implemented.)

2.8 Global Stop and Start Inputs (Optional)

This inputs allow to switch off the outputs channels (emergency stop) or to switch on all power supply outputs (e.g. used for maintenance) .

DSUB25 female	Pin	Signal	Comment
	1	NC	reserved
	14	NC	reserved
	2	NC	reserved
	15	NC	reserved
	3	NC	reserved
	16	NC	reserved
	4	NC	reserved
	17	NC	reserved
	5	NC	reserved
	18	NC	reserved
	6	NC	reserved
	19	NC	reserved
	7	NC	reserved
	20	NC	reserved
	8	NC	reserved
	21	NC	reserved
	9	NC	reserved
	22	NC	reserved
	10	NC	reserved
	23	NC	reserved
	11	NC	reserved
	24	NC	reserved
	12	STOP	reserved
	25	GND	Ground of the aux. supply, connected to USB ground
	13	START	Inhibit input

Table 6: Global Stop and Start Connector Pin Assignment

The signals shall be connected by a dry contact (e.g. relay), and must not be connected to other potentials.

The input has an internal 330 Ω pull-up resistor to 5V and an input impedance of 1 k Ω .

Signal	Functionality
STOP	If this signal is connected to GND (dry contact close), all power supply outputs are switched off. This functionality has priority over all other functions, it is not possible to switch outputs on in this state
START	If this signal is connected to GND (dry contact close), all power supply outputs are switched on. They will only be switched off in case of an emergency switch off caused by the supervision logic of the power supply. If this signal is not connected (dry contact open), power supply outputs may be switched on/off via SNMP or with the display control.

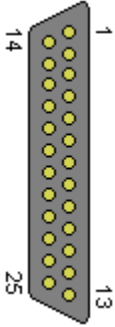
2.9 Alphanumeric Display (Optional)

This option allows the setup and display of some power supply items with toggle switches.

2.9.1 LED Description

- Power LED (green, 5mm) Lighting if the PL512/PL506 is operating. Channels may be on.
- Status LED (green, 3mm) Lighting if the main processor is working properly .
- Overheat (yellow) Lighting if the operating temperature inside of the power supply is too high.
- SYS FAIL (red) Processor malfunction.

2.9.2 Function of the Switches

After the PL512/PL506 has been switched on by pushing the “Power” switch up, the main operation modes can be selected by pushing the “Mode Select” switch up or down.

Many main operating modes do have one or more submenus, which can be accessed by a special procedure.

You will use the following switches of the PL512/PL506:

Symbol	Description	Remarks
P ▲	Push “Power” switch up (ON)	<p>Main power supply is off: Switch the power supply on. All power channels are off.</p> <p>Display shows a switched off channel: Switch this channel on.</p> <p>Submenu: OK button. Used to enter the selected submenu, request to change a value, accept the changes.</p>
P ▼	Push “Power” switch down (OFF)	<p>Display shows a switched off channel: Switch the main power supply and all channels off.</p> <p>Display shows a switched on channel: Switch this channel off.</p> <p>Submenu: CANCEL button. Used to leave a submenu, discard the changes.</p>
M ▲	Push “Mode Select” switch up	<p>Main operating mode: Select the next operating mode.</p> <p>Submenu: Change the selected item to the next possible state.</p>
M ▼	Push “Mode Select” switch down	<p>Main operating mode: Select the previous operating mode.</p> <p>Submenu: Change the selected item to the previous possible state.</p>

The following example describes the detailed steps to enter a sub menu and change the IP gateway address.

Description	Switch	Display ¹
switch the crate on	P ▲	U0 5.01V 1.2A
select the requested main operation mode	M ▲ or M ▼ (until right mode is displayed)	TCPIP: no link
enter submenu	M ▲ (push and hold), P ▲	Config: Wait
	hold both switches up	Config: Wait...
	after 4 seconds you can	Config: Ready !
	release the switches	TCPIP Address 192.168.91.80
Select submenu "TCPIP Gateway"	M ▲ or M ▼ (until right menu is displayed)	TCPIP Gateway 192.168.91.94
Enter this menu	P ▲	192.168.91.94
Change the value	M ▲ or M ▼	196.168.91.94
Accept change, to next item	P ▲	196.168.91.94
Accept change, to next item	P ▲	196.168.91.94
Accept change, to next item	P ▲	196.168.91.94
Ready, back to submenu selection	P ▲	TCPIP Gateway 196.168.91.94
Ready, leave submenu	M ▼	TCPIP: no link

2.9.3 Main Operating Modes and Associated Submenus

Operating Mode	Submenu	Display
Display voltage and current of the selected output channel		U0 5.01V 72.A
Display the TCP/IP connection state Possible values & symbols are: no link (no cable connected) 10M (connected to 10M network) 100M (connected to 100M network) HD (half duplex) FD (full duplex) ↓, ↑, ↕ (Frame received, transmitted, both)		Ethernet 100M FD

¹ Display: Two lines: displayed alternating, alternate background color: blinking

Operating Mode	Submenu	Display
	Change the TCP/IP address	TCPIP Address 192.168.91.80
	Change the TCP/IP subnet mask	TCPIP SubnetMask 255.255.255.224
	Change the TCP/IP gateway address	TCPIP Gateway 192.168.91.94
	Allow writes (e.g. switch on/off) via the web server	HTTP:read/write
	Change TCP/IP negotiation settings	TCPIPnegotiation AutoNegotiation
	Display of the ethernet hardware address (MAC). This address is written at the type plate, too.	TCPIP MAC Address 0050-C22D-C231
	Change the TCP/IP port of the web server	HTTP Port 80
	Change the TCP/IP port of the SNMP server	SNMP Port 161
	Restore the default SNMP settings (community strings)	SNMP Default No

2.10 Power Output and Sense Connections PL512

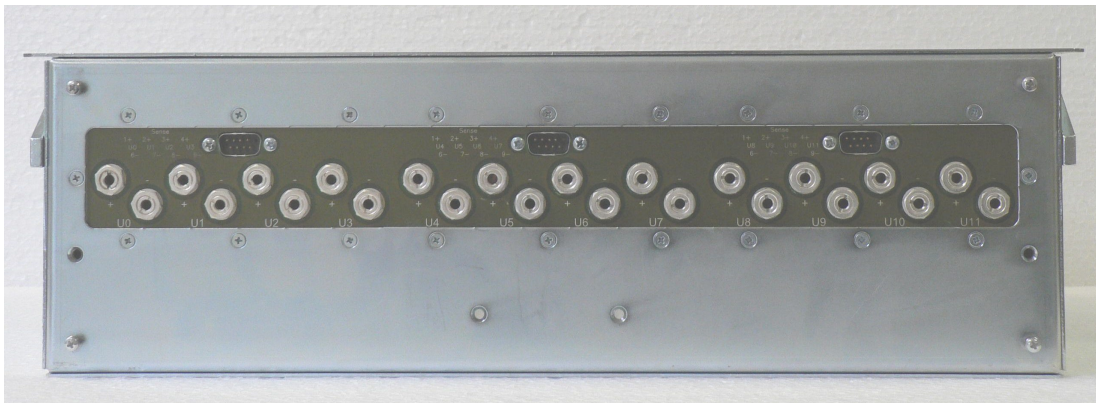

Figure 2.3: PL512 Rear Side (Power Output Connections)

The low voltage DC output at the rear side of the power supply is provided by 4 mm sockets. The channels are arranged from left to right starting with U0. Positive output is up and negative output is down.

The sense lines are routed to three DSUB connectors (four channels each).

SUB9 male	Pin	Left Connector (U0..U3)	Middle Connector (U4..U7)	Right Connector (U8..U11)
	1	U0 Sense +	U4 Sense +	U8 Sense +
	6	U0 Sense -	U4 Sense -	U8 Sense -
	2	U1 Sense +	U5 Sense +	U9 Sense +
	7	U1 Sense -	U5 Sense -	U9 Sense -
	3	U2 Sense +	U6 Sense +	U10 Sense +
	8	U2 Sense -	U6 Sense -	U10 Sense -
	4	U3 Sense +	U7 Sense +	U11 Sense +
	9	U3 Sense -	U7 Sense -	U11 Sense -
	5	not connected	not connected	not connected

Table 7: Sense Connector Pin Assignment

2.11 Power Output and Sense Connections PL506

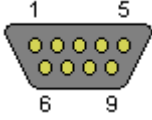
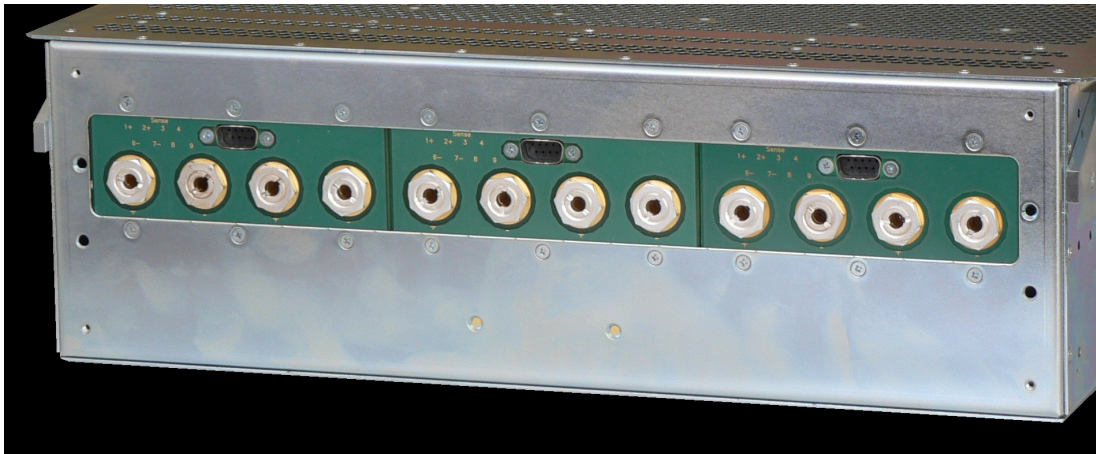

Figure 2.5: PL506 Rear Side (Power Output Connections)

The low voltage DC output at the rear side of the power supply is provided by 6 mm or 8mm sockets . The channels are arranged from left to right starting with U0. Positive output is up and negative output is down.

The sense lines are routed to three DSUB connectors (2 channels each).

DSUB9 male	Pin	Left Connector (U0..U3)	Middle Connector (U4..U7)	Right Connector (U8..U11)
	1	U0 Sense +	U2Sense +	U4 Sense +
	6	U0 Sense -	U2Sense -	U4 Sense -
	2	U1 Sense +	U3Sense +	U5 Sense +
	7	U1 Sense -	U3Sense -	U5 Sense -
	3	not connected	not connected	not connected
	8	not connected	not connected	not connected
	4	not connected	not connected	not connected
	9	not connected	not connected	not connected
	5	not connected	not connected	not connected

Table 8: Sense Connector Pin Assignment

3 PL512/PL506 Control and Setup via USB

The PL512/PL506 can be controlled with the MUSEcontrol software. Without the *Display* option this is the only way to change the network (TCP/IP) settings.

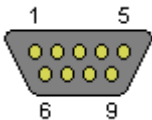

The USB interface is primarily intended to be used to configure the power supply. The Ethernet connection is designated for remote control and monitoring.

Requirements

- X86-Computer with USB connection (USB2 recommended)
- Microsoft Windows XP/VISTA/& or W8

Features

- Setup of the TCP/IP network parameters
- Global overview of all power supply channels
- Detailed configuration of the power supply channels
- Save and reload of configuration data

3.1 Installation

The installation software (MUSEcontrol-x.x.x.x.msi) is free available at the download area of our website (www.wiener-d.com → Support → Downloads).



Please install the software before connecting the power supply to the USB. The necessary USB-driver is included in the installation.

After downloading and executing the software Windows may complain that the supplier of the software could not be verified. Ignore this warning and select “Execute”.

Next the MUSEcontrol Setup Wizard welcome screen is displayed. Click “Next”, accept the license agreement and take a look at the ReadMe notes.

Now you may change the default installation folder and start the installation.



Now connect the PL512/PL506 with your mains supply and use an USB cable to connect the computer with the PL512/PL506.

The computer will detect the new connected hardware and ask to connect to Windows Update. Select “No” and click “Continue”.

Then accept the “Automatic install the software” selection by clicking “continue”.

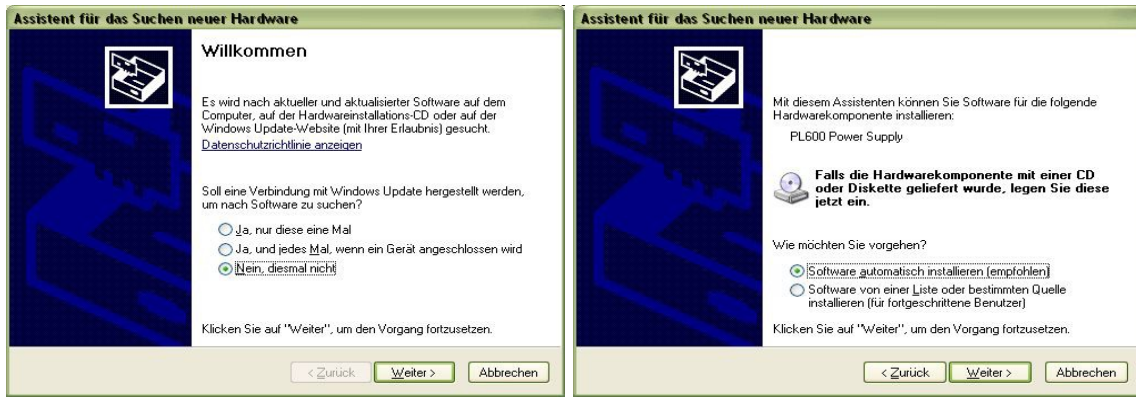

Now the USB driver software be installed. To access your power supply, execute the “WIENER USB Power Supply Control” application via your start menu.

3.2 The Main Window

After starting the application the main window shows a channel overview.

The measured sense voltage (Usense), current (Imodule) and terminal voltage (Umodule) and a global status of each channel are displayed.

Clicking with the left mouse button at a channel toggles the power state (OFF → ON or ON → OFF).

Clicking with the right mouse button opens the output configuration menu of this channel.

File	Switch...	SelectOutput	DVM	OutputConfiguration	System	Stop	Help
U0	Usense: 7.401V	I: -0.033A	Umodule: 8.057V	Status: ON			
U1	Usense: 6.304V	I: 0.019A	Umodule: 6.851V	Status: ON			
U2	Usense: 5.800V	I: -0.014A	Umodule: 6.307V	Status: ON			
U3	Usense: 4.995V	I: 0.012A	Umodule: 5.432V	Status: ON			
U4	Usense: 6.002V	I: -0.043A	Umodule: 6.534V	Status: ON			
U5	Usense: 5.998V	I: 0.000A	Umodule: 6.522V	Status: ON			
U6	Usense: 6.004V	I: -0.023A	Umodule: 6.524V	Status: ON			
U7	Usense: 6.000V	I: 0.049A	Umodule: 6.519V	Status: ON			
U8	Usense: 5.997V	I: -0.018A	Umodule: 6.522V	Status: ON			
U9	Usense: 6.005V	I: -0.006A	Umodule: 6.522V	Status: ON			
U10	Usense: 6.004V	I: -0.042A	Umodule: 6.525V	Status: ON			
U11	Usense: 5.995V	I: 0.025A	Umodule: 6.519V	Status: ON			

3.3 Description of the Menu Items

- File » Read Power Supply Configuration from File
Opens the Read Power Supply Data From File Dialog.
- File » Save Power Supply Configuration to File
Saves the complete power supply configuration to disk.
- Switch » All On
- Switch » All Off
Switches all power supply channels on or off.
- Switch » Group 1 On
- Switch » Group 1 Off
- Switch » Group 2 On
- Switch » Group 2 Off

This are commands to demonstrate the grouping functions of the PL512/PL506. The default factory setting is group 1 for channels 0..5 and group 2 for channels 6..11.

- SelectOutput

Select the next existing channel for the other dialogs. The current channel is displayed at the title bar.

- DVM
Opens a large window showing the measurement data of one channel.
- OutputConfiguration
Opens the Output Configuration Dialog.
- OutputCalibration
This dialog is reserved for service personal.
- System » Configuration
Opens the Global and Network Configuration Dialog.
- System » Firmware Update
Allows to update the firmware of the main processor.
- Stop
- Start
Allow to interrupt and resume the communication with the PL512/PL506.
- Help » Info
Here you have access to the version number of the software.

3.3.1 Read Power Supply Data From File Dialog

This dialog can be used to copy a XML configuration file from disk to the PL512/PL506.

It is possible to copy each configuration file channel to its corresponding power supply channel (e.g. U0 → U0, U1 → U1, ...) or to copy one configuration file channel to multiple power supply channels.

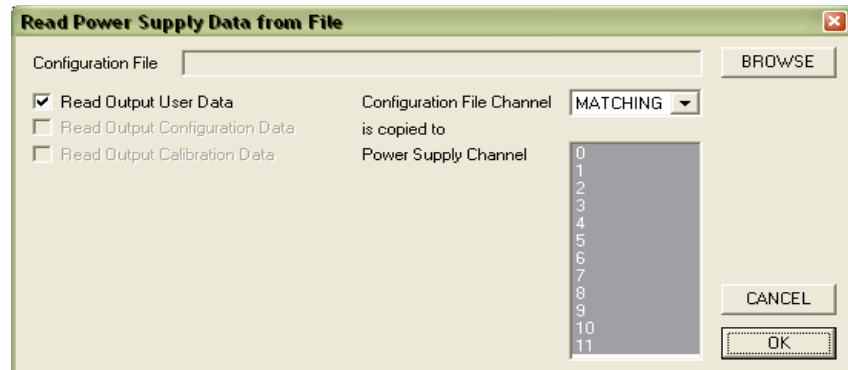

3.3.2 Output Configuration Dialog

This dialog allows the detailed configuration of each power supply channel.

The *Measurement* group shows the measured sense voltage, terminal voltage and current. The sense voltage is the voltage at the sense lines, which are connected to the load. Terminal voltage means the voltage at the terminals of the PL512/PL506.

Depending on the used modules, an analog or digital value of the most critical point of the power module is displayed.

The power of the load and the output power of the module are calculated values.

In the *Nominal Values* group the nominal values of the output voltage, the maximum current which the power supply will source before it switches into constant-current mode, and the voltage rise and fall rates are entered.

If the *No Ramp at Switch Off* check box is checked, the *Ramp Down* value is only used if the nominal voltage is changed. If the voltage is set to 0, the channel ramps down to zero and then switches off. But using the *OFF* button to switch off cuts off the output voltage immediately.

The voltage regulation parameters can be modified with the *Moderate Regulation* check box. If unchecked, the standard (PI) regulator is used. This is the fastest regulation, but may start ringing with wires to the load longer than 1 meter.

In this situations the advanced (PID) regulator of the *Moderate Regulation* should be used.

If the load is connected with really long or high-inductance cable, the *Slow Regulation* check box should be checked additionally. This increases the time constant of the I-Regulator.

The *Control and Status* group has buttons to switch the channel on or off. In case of any errors they are displayed here, too.

The *Supervision* group contains all items which the microcontroller can observe. In case of exceeding a limit, a dedicated action can be assigned to each item.

It is possible to

- ignore the failure (not possible at max. terminal voltage, max power and max. temperature: the power supply has to protect itself)
- switch this channel off
- switch all channels with the same group number off
- switch all channels of the power supply off

The Identification group contains just a single item, the group number of the channel.

Many SNMP network commands can address a single channel (identified by the channel number) or a group (identified by the group number), so it is possible to access different channels with only one network message.

3.3.3 Global and Network Configuration Dialog

In the *Network* group box you enter the TCP/IP network settings (IP address, subnet mask and default gateway). You have to use the parameters of your local network here. Please contact your network administrator for details.

HTTP and SNMP port numbers should only be modified if you know what you do. Setting any port to 0 disables the server.

If the “Channels Switch On with Main Switch” check box in the *Other* group box is checked, all output channels are switched on if the main switch is switched on.

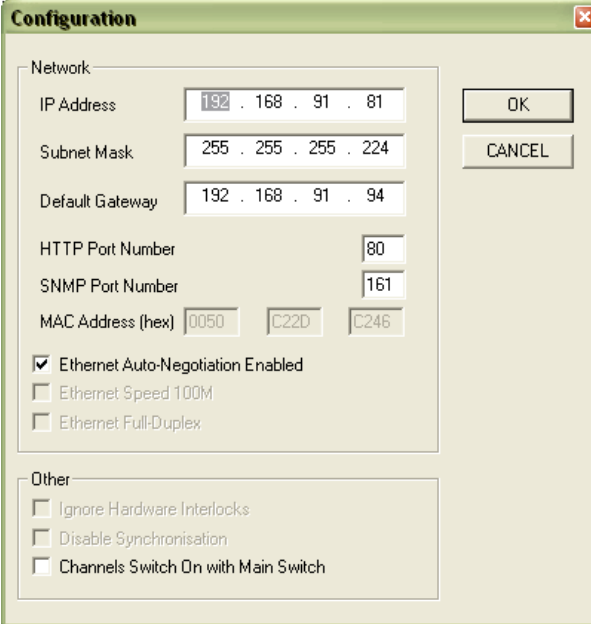

The screenshot shows a 'Configuration' dialog box with a title bar and a close button. It is divided into two main sections: 'Network' and 'Other'.
The 'Network' section contains:
- IP Address: 192 . 168 . 91 . 81
- Subnet Mask: 255 . 255 . 255 . 224
- Default Gateway: 192 . 168 . 91 . 94
- HTTP Port Number: 80
- SNMP Port Number: 161
- MAC Address (hex): 0050, C22D, C246
- Ethernet Auto-Negotiation Enabled:
- Ethernet Speed 100M:
- Ethernet Full-Duplex:
The 'Other' section contains:
- Ignore Hardware Interlocks:
- Disable Synchronisation:
- Channels Switch On with Main Switch:
Buttons for 'OK' and 'CANCEL' are located on the right side of the dialog.

4 PL-506/512 Wiring and First Use Instructions

4.1 Power Bins PBN506/PBN512

For easy exchange of the PL506 or PL512 Power Supply, (PS), the special bins PBN506/PBN512 are provided. The low voltage/high current cabling is connected to M6/M5 threaded bolts. For the **PL-512**: Starting from left with U0, positive outputs up – negative outputs down.

Each sense connector of four output channels are connected to an eightfold plug-able terminal row.

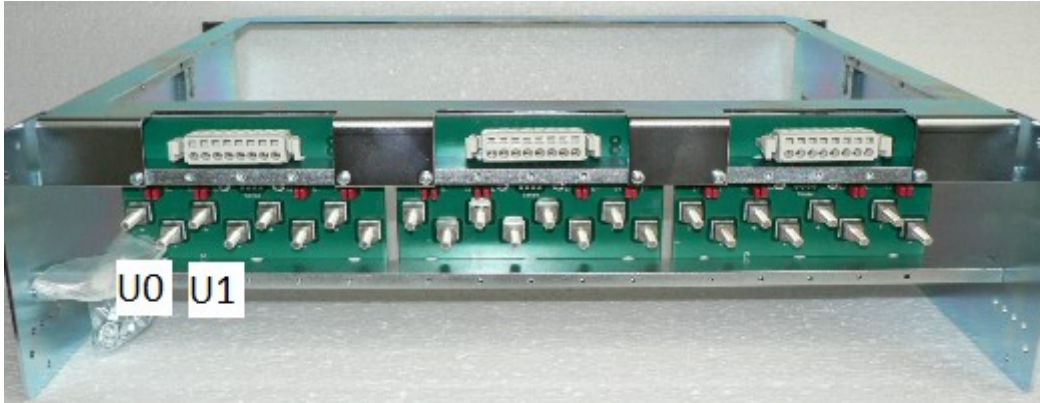

Fig. 4.1: PL-512 Power Bin, PBN512

For the **PL-506**: Starting from left with U0+ and right U0-. Each sense line of two output channels are connected to an eightfold plug-able terminal row. Last four terminals are unused.

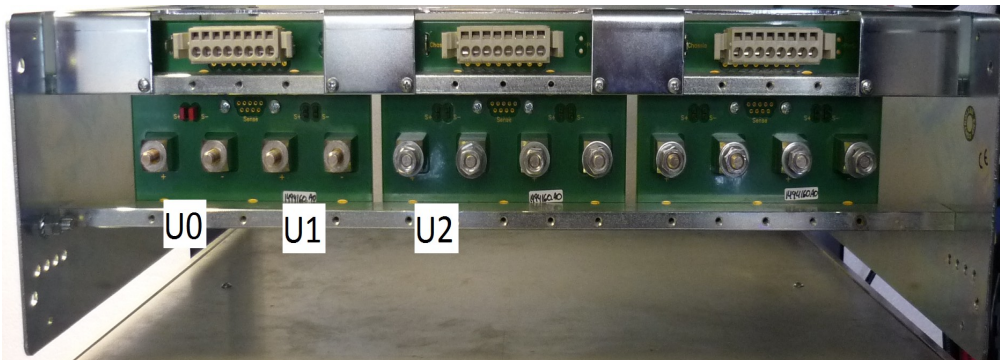

Fig 4.2: PL-506 Power Bin, PBN506

4.2 Sense Connections / Mode

Jumper on: internal sense used,

No Jumper : external sense enabled

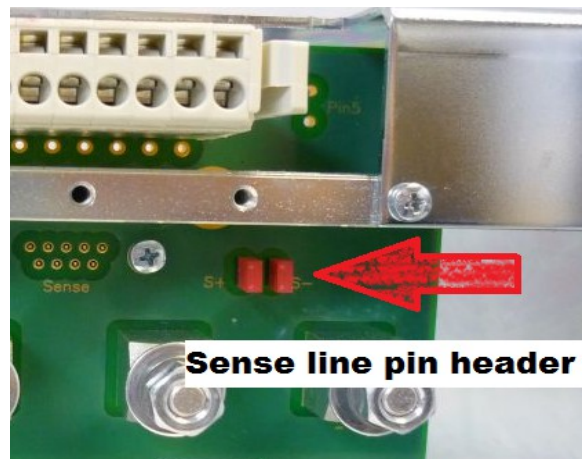

Fig. 4.3: PL-506, Sense Pin Header Jumpers

Use the plug-able sense connector for sense wiring. The PL-506 has only 4 sense connections per terminal block whereas the PL-512 has 8.

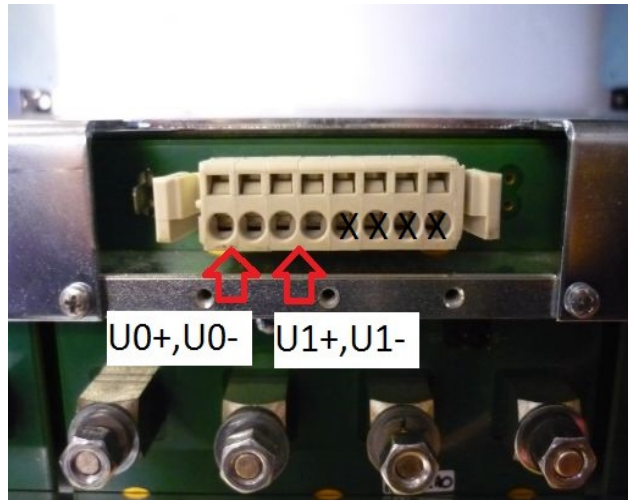

Fig 4.4: PL-506, sense connector for U0 and U1

4.3 Load Connections

Looking from the rear of the PS, the load connections are as follows: from left to right U0, U1, U2, U3 and so on. Fig.4.5- shows load and sense connections for U0. Use remote sense for load lines greater than 1m.

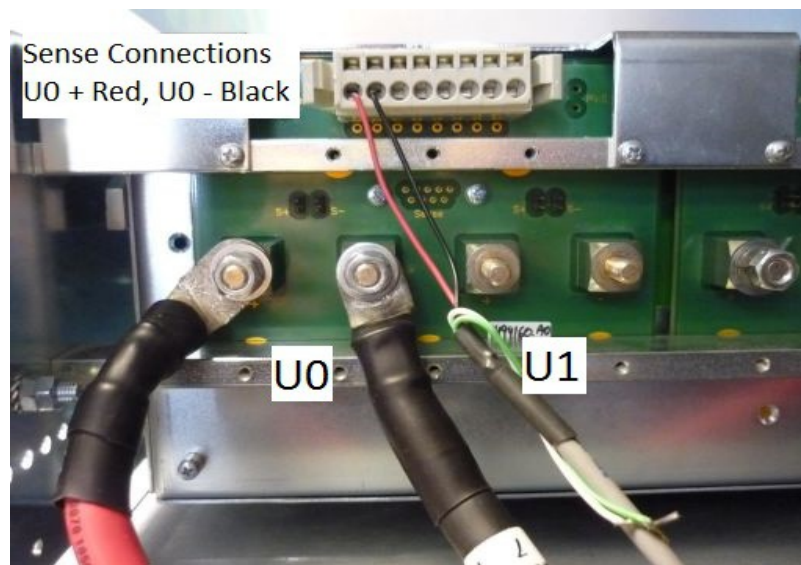

Fig. 4.5: PL-506- external sense

Use internal sense for testing and setup only! Once your load and load lines are setup, then connect sense lines for the most accurate control of load voltage and current.

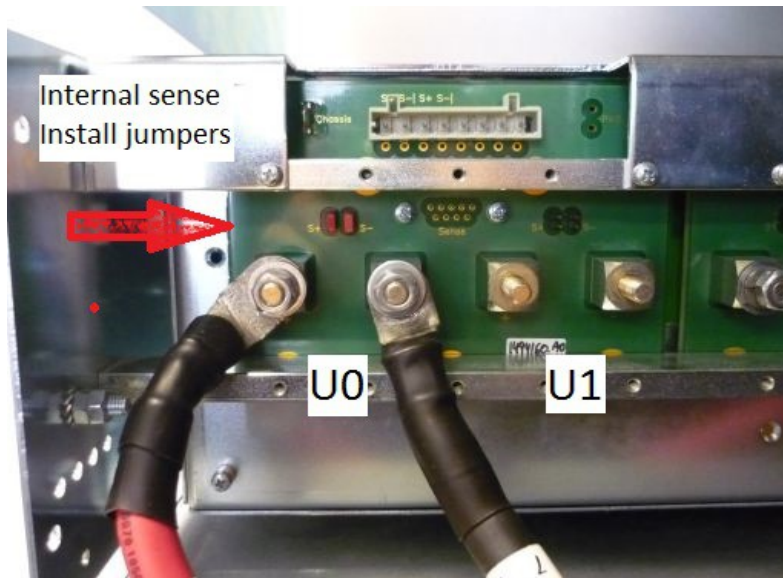

Fig. 4.6: PL-506-internal sense

Use shielded twisted cable for the sense lines. For the load lines use twisted cable to cancel EMI, (not shown in picture). Size the load lines appropriately for V drop and loads.

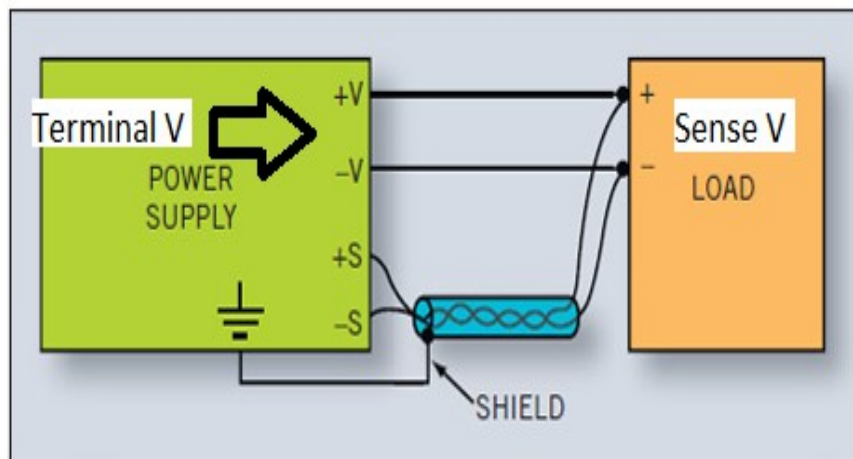

Fig. 4.7: Typical PS output wiring diagram

4.4 MUSEControl

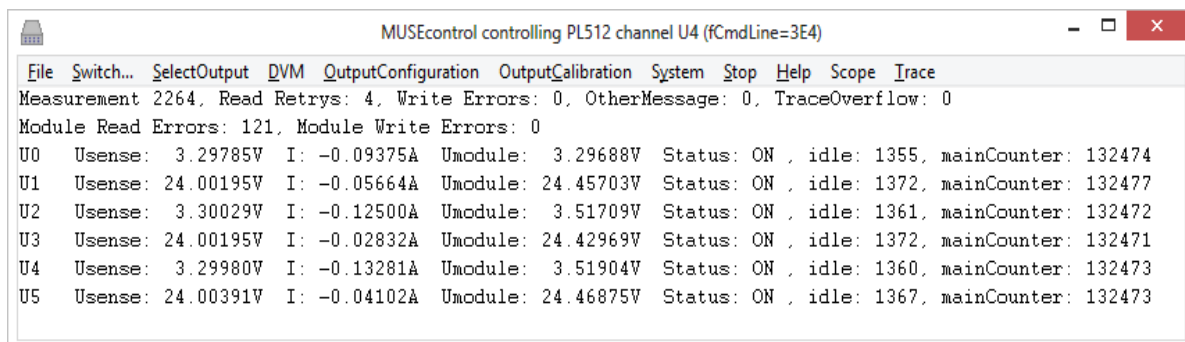

Fig. 4.8: PL-506, MUSEControl Main Window

Right click on a channel to open the Output Configuration Window.

The PS has supervision controls to protect itself and loaded circuits.

The user has complete control of PS parameters. The channel will not operate properly or even turn on without setting up the parameters correctly.

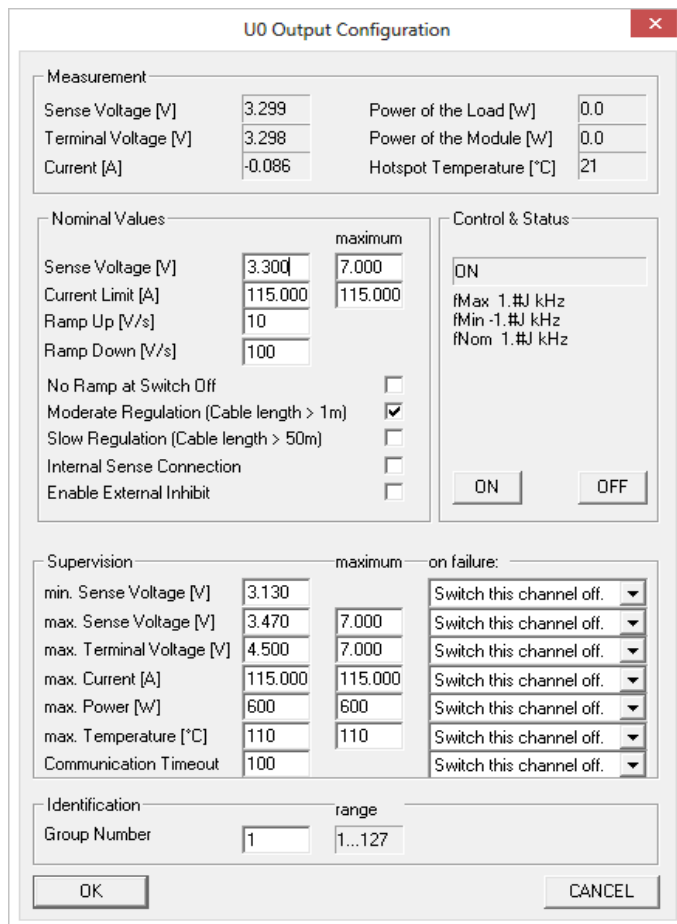

Fig. 4.9: U0 Output Configuration

Supervision:

Decide what is the permissible range of Sense Voltage[V]? Enter those values here,

Eg 3.130V and 3.470V respectively

Enter the maximum Terminal Voltage[V] permitted. The Terminal Voltage, will be higher than sense voltage as discussed previously. *Eg 4.50V*

Enter the max, Current, *Eg 115A or less.*

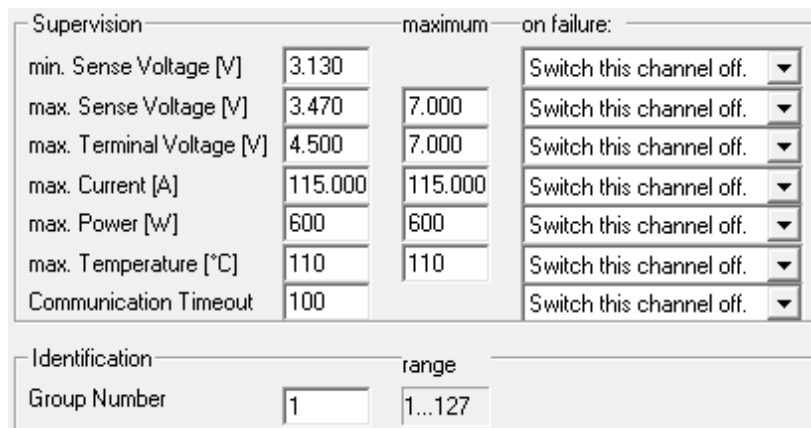

Fig. 4.10: Supervision Parameters

On the right hand side, “**on failure:**”, what would you like the PS to do if there is a supervision problem: Ignore this failure, Switch channel off, etc

Supervision		maximum	on failure:
min. Sense Voltage [V]	3.130		Switch this channel off. ▼
max. Sense Voltage [V]	3.470	7.000	Ignore this failure.
max. Terminal Voltage [V]	4.500	7.000	Switch this channel off.
max. Current [A]	115.000	115.000	Switch this group off.
max. Power [W]	600	600	Switch all channels off.
max. Temperature [°C]	110	110	Switch this channel off. ▼
Communication Timeout	100		Switch this channel off. ▼

Fig. 4.11: Supervision Problem

Nominal Values

Set the **Sense Voltage[V]**. It must be in range of the Supervision values entered previously.

Set the, “**Current Limit [A]**” as needed for your application.

See the *00679.A3 manual for more details regarding Ramp Up, Down, Regulation settings, etc. Download the latest manual at: <http://file.wiener-d.com/documentation/PL506-PL512/>

Nominal Values		maximum	Control & Status
Sense Voltage [V]	3.300	7.000	ON
Current Limit [A]	115.000	115.000	fMax 1.#J kHz
Ramp Up [V/s]	10		fMin -1.#J kHz
Ramp Down [V/s]	100		fNom 1.#J kHz
No Ramp at Switch Off		<input type="checkbox"/>	
Moderate Regulation (Cable length > 1m)		<input checked="" type="checkbox"/>	
Slow Regulation (Cable length > 50m)		<input type="checkbox"/>	
Internal Sense Connection		<input type="checkbox"/>	
Enable External Inhibit		<input type="checkbox"/>	
			ON OFF

Fig. 4.12: Nominal Values

5 Web Server

The PL512/PL506 has a built-in web-server which allows the monitoring of the power supply with a standard web browser.

Global Status				
Power Supply Status	ON			
Output Voltages				
Channel	Sense Voltage	Current	Terminal Voltage	Status
U0	7.401V	-0.031A	8.056V	ON
U1	6.303V	0.015A	6.851V	ON
U2	5.800V	-0.014A	6.307V	ON
U3	4.996V	0.013A	5.432V	ON
U4	6.001V	-0.050A	6.534V	ON
U5	5.998V	-0.001A	6.522V	ON
U6	6.003V	-0.022A	6.524V	ON
U7	6.000V	0.049A	6.518V	ON
U8	5.997V	-0.019A	6.521V	ON
U9	6.004V	-0.006A	6.522V	ON
U10	6.003V	-0.044A	6.525V	ON
U11	5.995V	0.023A	6.518V	ON

6 SNMP Control

The SNMP (Simple Network Management Protocol) is generally used to monitor and control computers and network routers. WIENER claimed a specific part of the SNMP name space and implemented power supply specific items there. Protocol version 1 and 2c is implemented. The tree view of the implemented items is appended in 8 SNMP OID Tree.

NetSNMP is an open source SNMP program which can be used to access the PL506/512 power supply via the Simple Network Management Protocol. Please see <http://net-snmp.sourceforge.net/> for more details.

Please install netSNMP from the CD-ROM or downloaded from the WIENER file server <http://file.wiener-d.com> on the control computer. In order to perform SNMP calls from any WIENER product the WIENER-CRATE-MIB file must be stored somewhere on the PC doing the calls, by default that location should be /usr/share/snmp/mibs (Windows: C:\usr\share\snmp\mibs).

The most commonly used net-snmp calls are:

snmpwalk – returns groups of parameters / items

snmpget – returns a specific parameter (read)

snmpset – sets a specific parameter (write)

Please see the netSNMP description and help files for detailed instructions and options. All parameters defined for WIENER crates and power supply systems are contained within the WIENER-CRATE-MIB.txt file.

A fast and easy way to begin using SNMP is to use command line arguments. The command line arguments specified in this document are based on netSNMP. The command line syntax is the same for both windows and Linux (and probably MAC OSX).

A first communication with the PL506 or PL512 power supply can be done using the **snmpwalk** to confirm the existence of the power supply at the given IP address. Please note that not all commands/parameters are supported by WIENER VME/VXI crates and PL5xx or MPOD power supplies.

snmpwalk -Cp -Oqv -v 2c -M \$path -m +WIENER-CRATE-MIB -c public \$ip

with:

snmpwalk: This command will retrieve a block of information.

-v 2c: This parameter specifies which version of the SNMP to use. WIENER devices use SNMP 2C.

-M \$path: This parameter should be replaced with the path to the WIENER-CRATE-MIB.txt file. It is not needed in case the default path is used.

-m +WIENER-CRATE-MIB: This parameter tells the command to look at the WIENER-CRATE-MIB to resolve the OID name.

-c public: This specifies which community of values can be accessed.

\$ip: This should be replaced with the IP address of the PL506/512.

Example for PL506 system with IP address 192.168.92.85:

snmpwalk -v 2c -m +WIENER-CRATE-MIB -c public 192.168.92.85

returns:

SSNMPv2-MIB::sysDescr.0 = STRING: WIENER Crate (, MUHSE 2.1.0.24, MPOD-BL 1.50)

SNMPv2-MIB::sysObjectID.0 = OID: WIENER-CRATE-MIB::sysMainSwitch.0

DISMAN-EVENT-MIB::sysUpTimeInstance = Timeticks: (208676) 0:34:46.76

SNMPv2-MIB::sysContact.0 = STRING:

SNMPv2-MIB::sysName.0 = STRING:

SNMPv2-MIB::sysLocation.0 = STRING:

SNMPv2-MIB::sysServices.0 = INTEGER: 79

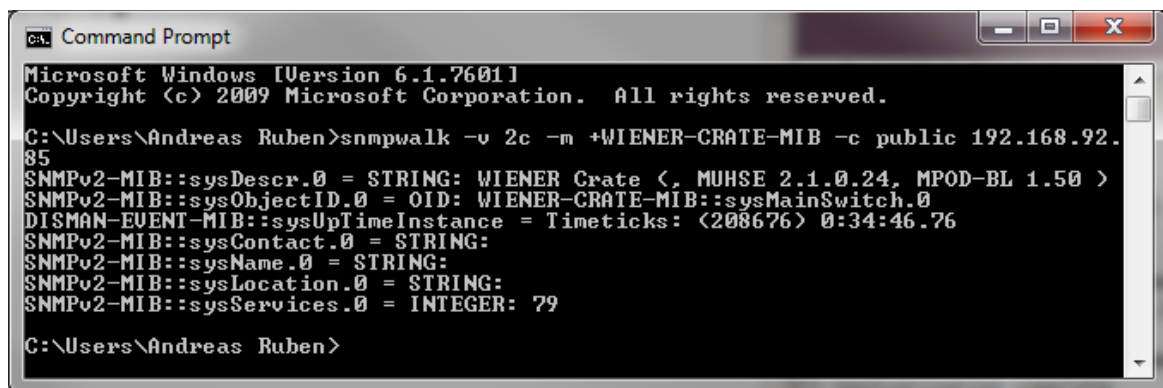

```
c:\ Command Prompt
Microsoft Windows [Version 6.1.7601]
Copyright (c) 2009 Microsoft Corporation. All rights reserved.

C:\Users\Andreas Ruben>snmpwalk -v 2c -m +WIENER-CRATE-MIB -c public 192.168.92.85
SNMPv2-MIB::sysDescr.0 = STRING: WIENER Crate (, MUHSE 2.1.0.24, MPOD-BL 1.50 )
SNMPv2-MIB::sysObjectID.0 = OID: WIENER-CRATE-MIB::sysMainSwitch.0
DISMAN-EVENT-MIB::sysUpTimeInstance = Timeticks: (208676) 0:34:46.76
SNMPv2-MIB::sysContact.0 = STRING:
SNMPv2-MIB::sysName.0 = STRING:
SNMPv2-MIB::sysLocation.0 = STRING:
SNMPv2-MIB::sysServices.0 = INTEGER: 79

C:\Users\Andreas Ruben>
```

A list of all available parameters or sub-parameters as for instance channels can be obtained using the command snmpwalk with the parameter "crate". To get all parameters use:

snmpwalk -Cp -Oqv -v 2c -M \$path -m +WIENER-CRATE-MIB -c public \$ip crate

example:

snmpwalk -v 2c -m +WIENER-CRATE-MIB -c public 192.168.92.85 crate

returns for a PL506 :

WIENER-CRATE-MIB::sysMainSwitch.0 = INTEGER: off(0)

WIENER-CRATE-MIB::sysStatus.0 = BITS: 00
WIENER-CRATE-MIB::sysHardwareReset.0 = INTEGER: 0
WIENER-CRATE-MIB::outputNumber.0 = INTEGER: 6
WIENER-CRATE-MIB::outputIndex.u0 = INTEGER: u0(1)
WIENER-CRATE-MIB::outputIndex.u1 = INTEGER: u1(2)
WIENER-CRATE-MIB::outputIndex.u2 = INTEGER: u2(3)
WIENER-CRATE-MIB::outputIndex.u3 = INTEGER: u3(4)
WIENER-CRATE-MIB::outputIndex.u4 = INTEGER: u4(5)
WIENER-CRATE-MIB::outputIndex.u5 = INTEGER: u5(6)
WIENER-CRATE-MIB::outputName.u0 = STRING: U0
WIENER-CRATE-MIB::outputName.u1 = STRING: U1
WIENER-CRATE-MIB::outputName.u2 = STRING: U2
WIENER-CRATE-MIB::outputName.u3 = STRING: U3
WIENER-CRATE-MIB::outputName.u4 = STRING: U4
WIENER-CRATE-MIB::outputName.u5 = STRING: U5
WIENER-CRATE-MIB::outputGroup.u0 = INTEGER: 1
WIENER-CRATE-MIB::outputGroup.u1 = INTEGER: 2
WIENER-CRATE-MIB::outputGroup.u2 = INTEGER: 1
WIENER-CRATE-MIB::outputGroup.u3 = INTEGER: 2
WIENER-CRATE-MIB::outputGroup.u4 = INTEGER: 1
WIENER-CRATE-MIB::outputGroup.u5 = INTEGER: 2
WIENER-CRATE-MIB::outputStatus.u0 = BITS: 40 outputInhibit(1)
WIENER-CRATE-MIB::outputStatus.u1 = BITS: 40 outputInhibit(1)
WIENER-CRATE-MIB::outputStatus.u2 = BITS: 40 outputInhibit(1)
WIENER-CRATE-MIB::outputStatus.u3 = BITS: 40 outputInhibit(1)
WIENER-CRATE-MIB::outputStatus.u4 = BITS: 40 outputInhibit(1)
WIENER-CRATE-MIB::outputStatus.u5 = BITS: 40 outputInhibit(1)
WIENER-CRATE-MIB::outputMeasurementSenseVoltage.u0 = Opaque: Float: 0.000000 V
WIENER-CRATE-MIB::outputMeasurementSenseVoltage.u1 = Opaque: Float: 0.000000 V
WIENER-CRATE-MIB::outputMeasurementSenseVoltage.u2 = Opaque: Float: 0.000000 V
WIENER-CRATE-MIB::outputMeasurementSenseVoltage.u3 = Opaque: Float: 0.000000 V
WIENER-CRATE-MIB::outputMeasurementSenseVoltage.u4 = Opaque: Float: 0.000000 V
WIENER-CRATE-MIB::outputMeasurementSenseVoltage.u5 = Opaque: Float: 0.000000 V
WIENER-CRATE-MIB::outputMeasurementTerminalVoltage.u0 = Opaque: Float: 0.000000V
WIENER-CRATE-MIB::outputMeasurementTerminalVoltage.u1 = Opaque: Float: 0.000000V
WIENER-CRATE-MIB::outputMeasurementTerminalVoltage.u2 = Opaque: Float: 0.000000V
WIENER-CRATE-MIB::outputMeasurementTerminalVoltage.u3 = Opaque: Float: 0.000000V
WIENER-CRATE-MIB::outputMeasurementTerminalVoltage.u4 = Opaque: Float: 0.000000V
WIENER-CRATE-MIB::outputMeasurementTerminalVoltage.u5 = Opaque: Float: 0.000000V
WIENER-CRATE-MIB::outputMeasurementCurrent.u0 = Opaque: Float: 0.000000 A
WIENER-CRATE-MIB::outputMeasurementCurrent.u1 = Opaque: Float: 0.000000 A
WIENER-CRATE-MIB::outputMeasurementCurrent.u2 = Opaque: Float: 0.000000 A
WIENER-CRATE-MIB::outputMeasurementCurrent.u3 = Opaque: Float: 0.000000 A
WIENER-CRATE-MIB::outputMeasurementCurrent.u4 = Opaque: Float: 0.000000 A
WIENER-CRATE-MIB::outputMeasurementCurrent.u5 = Opaque: Float: 0.000000 A
WIENER-CRATE-MIB::outputMeasurementTemperature.u0 = INTEGER: 24
WIENER-CRATE-MIB::outputMeasurementTemperature.u1 = INTEGER: 25
WIENER-CRATE-MIB::outputMeasurementTemperature.u2 = INTEGER: 24
WIENER-CRATE-MIB::outputMeasurementTemperature.u3 = INTEGER: 26
WIENER-CRATE-MIB::outputMeasurementTemperature.u4 = INTEGER: 25
WIENER-CRATE-MIB::outputMeasurementTemperature.u5 = INTEGER: 29
WIENER-CRATE-MIB::outputSwitch.u0 = INTEGER: off(0)
WIENER-CRATE-MIB::outputSwitch.u1 = INTEGER: off(0)
WIENER-CRATE-MIB::outputSwitch.u2 = INTEGER: off(0)
WIENER-CRATE-MIB::outputSwitch.u3 = INTEGER: off(0)
WIENER-CRATE-MIB::outputSwitch.u4 = INTEGER: off(0)
WIENER-CRATE-MIB::outputSwitch.u5 = INTEGER: off(0)
WIENER-CRATE-MIB::outputVoltage.u0 = Opaque: Float: 3.299805 V

WIENER-CRATE-MIB::outputVoltage.u1 = Opaque: Float: 24.000000 V
WIENER-CRATE-MIB::outputVoltage.u2 = Opaque: Float: 3.300293 V
WIENER-CRATE-MIB::outputVoltage.u3 = Opaque: Float: 24.000000 V
WIENER-CRATE-MIB::outputVoltage.u4 = Opaque: Float: 3.299805 V
WIENER-CRATE-MIB::outputVoltage.u5 = Opaque: Float: 24.000000 V
WIENER-CRATE-MIB::outputCurrent.u0 = Opaque: Float: 115.000000 A
WIENER-CRATE-MIB::outputCurrent.u1 = Opaque: Float: 23.000000 A
WIENER-CRATE-MIB::outputCurrent.u2 = Opaque: Float: 115.000000 A
WIENER-CRATE-MIB::outputCurrent.u3 = Opaque: Float: 23.000000 A
WIENER-CRATE-MIB::outputCurrent.u4 = Opaque: Float: 115.000000 A
WIENER-CRATE-MIB::outputCurrent.u5 = Opaque: Float: 23.000000 A
WIENER-CRATE-MIB::outputVoltageRiseRate.u0 = Opaque: Float: 100.000000 V/s
WIENER-CRATE-MIB::outputVoltageRiseRate.u1 = Opaque: Float: 100.000000 V/s
WIENER-CRATE-MIB::outputVoltageRiseRate.u2 = Opaque: Float: 100.000000 V/s
WIENER-CRATE-MIB::outputVoltageRiseRate.u3 = Opaque: Float: 100.000000 V/s
WIENER-CRATE-MIB::outputVoltageRiseRate.u4 = Opaque: Float: 100.000000 V/s
WIENER-CRATE-MIB::outputVoltageRiseRate.u5 = Opaque: Float: 100.000000 V/s
WIENER-CRATE-MIB::outputVoltageFallRate.u0 = Opaque: Float: 100.000000 V/s
WIENER-CRATE-MIB::outputVoltageFallRate.u1 = Opaque: Float: 100.000000 V/s
WIENER-CRATE-MIB::outputVoltageFallRate.u2 = Opaque: Float: 100.000000 V/s
WIENER-CRATE-MIB::outputVoltageFallRate.u3 = Opaque: Float: 100.000000 V/s
WIENER-CRATE-MIB::outputVoltageFallRate.u4 = Opaque: Float: 100.000000 V/s
WIENER-CRATE-MIB::outputVoltageFallRate.u5 = Opaque: Float: 100.000000 V/s
WIENER-CRATE-MIB::outputSupervisionBehavior.u0 = INTEGER: 17749
WIENER-CRATE-MIB::outputSupervisionBehavior.u1 = INTEGER: 17749
WIENER-CRATE-MIB::outputSupervisionBehavior.u2 = INTEGER: 17749
WIENER-CRATE-MIB::outputSupervisionBehavior.u3 = INTEGER: 17749
WIENER-CRATE-MIB::outputSupervisionBehavior.u4 = INTEGER: 17749
WIENER-CRATE-MIB::outputSupervisionBehavior.u5 = INTEGER: 17749
WIENER-CRATE-MIB::outputSupervisionMinSenseVoltage.u0 = Opaque: Float: 3.129883V
WIENER-CRATE-MIB::outputSupervisionMinSenseVoltage.u1 = Opaque: Float: 22.799805 V
WIENER-CRATE-MIB::outputSupervisionMinSenseVoltage.u2 = Opaque: Float: 3.129883V
WIENER-CRATE-MIB::outputSupervisionMinSenseVoltage.u3 = Opaque: Float: 22.799805 V
WIENER-CRATE-MIB::outputSupervisionMinSenseVoltage.u4 = Opaque: Float: 3.129883V
WIENER-CRATE-MIB::outputSupervisionMinSenseVoltage.u5 = Opaque: Float: 22.799805 V
WIENER-CRATE-MIB::outputSupervisionMaxSenseVoltage.u0 = Opaque: Float: 3.470215V
WIENER-CRATE-MIB::outputSupervisionMaxSenseVoltage.u1 = Opaque: Float: 25.200195 V
WIENER-CRATE-MIB::outputSupervisionMaxSenseVoltage.u2 = Opaque: Float: 3.470215V
WIENER-CRATE-MIB::outputSupervisionMaxSenseVoltage.u3 = Opaque: Float: 25.200195 V
WIENER-CRATE-MIB::outputSupervisionMaxSenseVoltage.u4 = Opaque: Float: 3.470215V
WIENER-CRATE-MIB::outputSupervisionMaxSenseVoltage.u5 = Opaque: Float: 25.200195 V
WIENER-CRATE-MIB::outputSupervisionMaxTerminalVoltage.u0 = Opaque: Float: 4.500000 V
WIENER-CRATE-MIB::outputSupervisionMaxTerminalVoltage.u1 = Opaque: Float: 27.000000 V
WIENER-CRATE-MIB::outputSupervisionMaxTerminalVoltage.u2 = Opaque: Float: 4.500000 V
WIENER-CRATE-MIB::outputSupervisionMaxTerminalVoltage.u3 = Opaque: Float: 27.000000 V
WIENER-CRATE-MIB::outputSupervisionMaxTerminalVoltage.u4 = Opaque: Float: 4.500000 V
WIENER-CRATE-MIB::outputSupervisionMaxTerminalVoltage.u5 = Opaque: Float: 27.000000 V
WIENER-CRATE-MIB::outputSupervisionMaxCurrent.u0 = Opaque: Float: 115.000000 A
WIENER-CRATE-MIB::outputSupervisionMaxCurrent.u1 = Opaque: Float: 23.000000 A
WIENER-CRATE-MIB::outputSupervisionMaxCurrent.u2 = Opaque: Float: 115.000000 A
WIENER-CRATE-MIB::outputSupervisionMaxCurrent.u3 = Opaque: Float: 23.000000 A
WIENER-CRATE-MIB::outputSupervisionMaxCurrent.u4 = Opaque: Float: 115.000000 A
WIENER-CRATE-MIB::outputSupervisionMaxCurrent.u5 = Opaque: Float: 23.000000 A
WIENER-CRATE-MIB::outputSupervisionMaxTemperature.u0 = INTEGER: 110 deg C
WIENER-CRATE-MIB::outputSupervisionMaxTemperature.u1 = INTEGER: 110 deg C
WIENER-CRATE-MIB::outputSupervisionMaxTemperature.u2 = INTEGER: 110 deg C
WIENER-CRATE-MIB::outputSupervisionMaxTemperature.u3 = INTEGER: 110 deg C
WIENER-CRATE-MIB::outputSupervisionMaxTemperature.u4 = INTEGER: 110 deg C

WIENER-CRATE-MIB::outputSupervisionMaxTemperature.u5 = INTEGER: 110 deg C
WIENER-CRATE-MIB::outputConfigMaxSenseVoltage.u0 = Opaque: Float: 15.999512 V
WIENER-CRATE-MIB::outputConfigMaxSenseVoltage.u1 = Opaque: Float: 31.999023 V
WIENER-CRATE-MIB::outputConfigMaxSenseVoltage.u2 = Opaque: Float: 15.999512 V
WIENER-CRATE-MIB::outputConfigMaxSenseVoltage.u3 = Opaque: Float: 31.999023 V
WIENER-CRATE-MIB::outputConfigMaxSenseVoltage.u4 = Opaque: Float: 15.999512 V
WIENER-CRATE-MIB::outputConfigMaxSenseVoltage.u5 = Opaque: Float: 31.999023 V
WIENER-CRATE-MIB::outputConfigMaxTerminalVoltage.u0 = Opaque: Float: 15.999512 V
WIENER-CRATE-MIB::outputConfigMaxTerminalVoltage.u1 = Opaque: Float: 31.999023 V
WIENER-CRATE-MIB::outputConfigMaxTerminalVoltage.u2 = Opaque: Float: 15.999512 V
WIENER-CRATE-MIB::outputConfigMaxTerminalVoltage.u3 = Opaque: Float: 31.999023 V
WIENER-CRATE-MIB::outputConfigMaxTerminalVoltage.u4 = Opaque: Float: 15.999512 V
WIENER-CRATE-MIB::outputConfigMaxTerminalVoltage.u5 = Opaque: Float: 31.999023 V
WIENER-CRATE-MIB::outputConfigMaxCurrent.u0 = Opaque: Float: 255.992188 A
WIENER-CRATE-MIB::outputConfigMaxCurrent.u1 = Opaque: Float: 31.999023 A
WIENER-CRATE-MIB::outputConfigMaxCurrent.u2 = Opaque: Float: 255.992188 A
WIENER-CRATE-MIB::outputConfigMaxCurrent.u3 = Opaque: Float: 31.999023 A
WIENER-CRATE-MIB::outputConfigMaxCurrent.u4 = Opaque: Float: 255.992188 A
WIENER-CRATE-MIB::outputConfigMaxCurrent.u5 = Opaque: Float: 31.999023 A
WIENER-CRATE-MIB::outputSupervisionMaxPower.u0 = Opaque: Float: 600.000000 W
WIENER-CRATE-MIB::outputSupervisionMaxPower.u1 = Opaque: Float: 550.000000 W
WIENER-CRATE-MIB::outputSupervisionMaxPower.u2 = Opaque: Float: 600.000000 W
WIENER-CRATE-MIB::outputSupervisionMaxPower.u3 = Opaque: Float: 550.000000 W
WIENER-CRATE-MIB::outputSupervisionMaxPower.u4 = Opaque: Float: 600.000000 W
WIENER-CRATE-MIB::outputSupervisionMaxPower.u5 = Opaque: Float: 550.000000 W
WIENER-CRATE-MIB::outputRegulationMode.u0 = INTEGER: moderate(1)
WIENER-CRATE-MIB::outputRegulationMode.u1 = INTEGER: moderate(1)
WIENER-CRATE-MIB::outputRegulationMode.u2 = INTEGER: moderate(1)
WIENER-CRATE-MIB::outputRegulationMode.u3 = INTEGER: moderate(1)
WIENER-CRATE-MIB::outputRegulationMode.u4 = INTEGER: moderate(1)
WIENER-CRATE-MIB::outputRegulationMode.u5 = INTEGER: moderate(1)
WIENER-CRATE-MIB::outputConfigMaxTemperature.u0 = INTEGER: 110 deg C
WIENER-CRATE-MIB::outputConfigMaxTemperature.u1 = INTEGER: 110 deg C
WIENER-CRATE-MIB::outputConfigMaxTemperature.u2 = INTEGER: 110 deg C
WIENER-CRATE-MIB::outputConfigMaxTemperature.u3 = INTEGER: 110 deg C
WIENER-CRATE-MIB::outputConfigMaxTemperature.u4 = INTEGER: 110 deg C
WIENER-CRATE-MIB::outputConfigMaxTemperature.u5 = INTEGER: 110 deg C
WIENER-CRATE-MIB::groupsNumber.0 = INTEGER: 4
WIENER-CRATE-MIB::groupsIndex.0 = INTEGER: 0
WIENER-CRATE-MIB::groupsIndex.1 = INTEGER: 1
WIENER-CRATE-MIB::groupsIndex.2 = INTEGER: 2
WIENER-CRATE-MIB::groupsSwitch.0 = INTEGER: undefined(-1)
WIENER-CRATE-MIB::groupsSwitch.1 = INTEGER: undefined(-1)
WIENER-CRATE-MIB::groupsSwitch.2 = INTEGER: undefined(-1)
WIENER-CRATE-MIB::snmpCommunityName.public = STRING: "public"
WIENER-CRATE-MIB::snmpPort.0 = INTEGER: 161
WIENER-CRATE-MIB::firmwareUpdate.0 = ""
WIENER-CRATE-MIB::ipDynamicAddress.0 = IpAddress: 192.168.92.85
WIENER-CRATE-MIB::ipStaticAddress.0 = IpAddress: 192.168.92.85
WIENER-CRATE-MIB::macAddress.0 = Hex-STRING: 00 50 C2 2D CB D9
WIENER-CRATE-MIB::psSerialNumber.0 = STRING:
WIENER-CRATE-MIB::psOperatingTime.0 = INTEGER: 790593 s
WIENER-CRATE-MIB::psOperatingTime.0 = No more variables left in this MIB View (1
t is past the end of the MIB tree)

Further it is possible obtain the array of names or values for a specific parameter. The following command provides a list of all existing output channels:

snmpwalk -Cp -Oqv -v 2c -M \$path -m +WIENER-CRATE-MIB -c public \$ip outputName

Example:

snmpwalk -v 2c -m +WIENER-CRATE-MIB -c public 192.168.92.25 outputName

```
WIENER-CRATE-MIB::outputName.u0 = STRING: U0
WIENER-CRATE-MIB::outputName.u1 = STRING: U1
WIENER-CRATE-MIB::outputName.u2 = STRING: U2
WIENER-CRATE-MIB::outputName.u3 = STRING: U3
WIENER-CRATE-MIB::outputName.u4 = STRING: U4
WIENER-CRATE-MIB::outputName.u5 = STRING: U5
```

To see all output channel set voltage values use snmpwalk with outputVoltage:

snmpwalk -Cp -Oqv -v 2c -M \$path -m +WIENER-CRATE-MIB -c public \$ip outputVoltage

Example:

snmpwalk -v 2c -m +WIENER-CRATE-MIB -c public 192.168.2.25 outputVoltage

```
WIENER-CRATE-MIB::outputVoltage.u0 = Opaque: Float: 3.299805 V
WIENER-CRATE-MIB::outputVoltage.u1 = Opaque: Float: 24.000000 V
WIENER-CRATE-MIB::outputVoltage.u2 = Opaque: Float: 3.300293 V
WIENER-CRATE-MIB::outputVoltage.u3 = Opaque: Float: 24.000000 V
WIENER-CRATE-MIB::outputVoltage.u4 = Opaque: Float: 3.299805 V
WIENER-CRATE-MIB::outputVoltage.u5 = Opaque: Float: 24.000000 V
```

After obtaining information about the power supplies or a list of channels and parameters, it is useful to be able to write or read information about it. This can be done using the **snmpget** and **snmpset** commands.

snmpget -Oqv -v 2c -M \$path -m +WIENER-CRATE-MIB -c guru \$ip name.index

snmpset -v 2c -M \$path -m +WIENER-CRATE-MIB -c guru \$ip name.index format value

The most common kind of call you will want is to get data from the power supply. This is easily done via the **snmpget** command. The example below retrieves information about whether the main power for the crate is on. If you wish to test this example on your own system replace “\$path” with the path to WIENER-CRATE-MIB.txt (/usr/share/snmp/mibs by default and “\$ip” with the ip address of your MPOD (see following examples).

snmpget -v 2c -M \$path -m +WIENER-CRATE-MIB -c public \$ip sysMainSwitch.0

Example:

snmpget -v 2c -m +WIENER-CRATE-MIB -c public 192.168.92.85 sysMainSwitch.0

```
WIENER-CRATE-MIB::sysMainSwitch.0 = INTEGER: off(0)
```

This indicates that the crate or power supply is currently off. To better understand the call above we will break it down by parameter:

snmpget: This command will retrieve a value from the PL506/512.

-v 2c: This parameter specifies which version of the SNMP to use. WIENER devices use SNMP 2C.

-M \$path: This parameter should be replaced with the path to the WIENER-CRATE-MIB.txt file.

-m +WIENER-CRATE-MIB: This parameter tells the command to look at the WIENER-CRATE-MIB to resolve the OID name.

-c public: This specifies which community of values can be accessed.

\$ip: This should be replaced with the IP address of the PL506/512.

sysMainSwitch.0: This is the register you wish to retrieve.

Since we know from the call above that the power supply is off, we may want to turn it on. To turn the PL506/512 on, we can use the command:

snmpset -v 2c - path -m +WIENER-CRATE-MIB -c COMMUNITY \$ip sysMainSwitch.0 i 1

Depending on the device type the community may be “public” for reading or “private” / “guru” for write calls. In case the wrong community code is used a “not writable” error message will be received.

Example:

snmpset -v 2c -m +WIENER-CRATE-MIB -c private 192.168.92.85 sysMainSwitch.0 i 1

WIENER-CRATE-MIB::sysMainSwitch.0 = INTEGER: on(1)

Most of the parameters for snmpset are the same as snmpget, the new parameters are highlighted below.

i: Since sysMainSwitch.0 is an integer value, we specify the value to be an integer with.

1: This is the value we wish to write. In this case we write ‘one’ to set the main switch to on.

For most of the write commands (snmpset) the access type has to be changed from public to guru.

A complete list of value names that can be written or read via SNMP can be found in the WIENER-CRATE-MIB file with detailed description but commonly needed values are:

Value Name	Type	Access	Comments
outputVoltage	Float	R/W	The Channel set Voltage
outputCurrent	Float	R/W	The channel current limit
outputMeasurementSenseVoltage	Float	R	Actual channel Voltage mesaured at sense line
outputSwitch	Integer	R/W	Turns channel ON/OFF
outputStatus	Bits	R	Channel Status information
outputMeasurementTerminalVoltage	Float	R	Actual channel Voltage measured at terminal
outputMeasurementCurrent	Float	R	Actual channel current
outputMeasurementTemperature	Integer	R	Temperature on power module/channel
outputVoltageRiseRate	Float	R/W	Channel ramp up rate
outputVoltageFallRate	Float	R/W	Channel ramp down rate
outputRegulationMode	Integer	R/W	Fast, moderate or slow regulation

For example, to read channel set voltage use:

snmpget -Oqv -v 2c -M \$path -m +WIENER-CRATE-MIB -c guru \$ip outputVoltage.index

Example:

snmpget -v 2c -m +WIENER-CRATE-MIB -c public 192.168.92.85 outputVoltage.001

WIENER-CRATE-MIB::outputVoltage.u0 = Opaque: Float: 3.299805 V

Write and read individual set voltages, “guru” access needed to write!

snmpset -v 2c -m +WIENER-CRATE-MIB -c guru 192.168.92.85 outputVoltage.001 F 4.0

WIENER-CRATE-MIB::outputVoltage.u0 = Opaque: Float: 4.000000 V

Note the “F” before the 4.0, this indicates that the value is a floating point number.

The individual channels of PL506 and PL512 power supply can be turned on and off. To turn on channel Ux:

snmpset -Oqv -v 2c -M \$path -m +WIENER-CRATE-MIB -c guru \$ip outputSwitch.index i 1

The same channel can be turned off with:

```
snmpset -Oqv -v 2c -M $path -m +WIENER-CRATE-MIB -c guru $ip outputSwitch.index i 0
```

Example for switching on the first channel:

```
snmpset -v 2c -m +WIENER-CRATE-MIB -c guru 192.168.92.85 outputSwitch.u0 i 1
```

```
WIENER-CRATE-MIB::outputSwitch.u0 = INTEGER: on(1)
```

PL506 / 512 channels have programmable voltage ramp speeds for both up and down direction:

```
snmpset -Oqv -v 2c -M $path -m +WIENER-CRATE-MIB -c guru $ip outputVoltageRiseRate.index F value
```

Example:

```
snmpset -v 2c -m +WIENER-CRATE-MIB -c guru 192.168.92.85 outputVoltageRiseRate.u0 F 10.0
```

```
WIENER-CRATE-MIB::outputVoltageRiseRate.u0 = Opaque: Float: 10.000000 V/s
```

```
snmpset -v 2c -m +WIENER-CRATE-MIB -c guru 192.168.92.85 outputVoltageFallRate.u0 F 100.0
```

```
WIENER-CRATE-MIB::outputVoltageFallRate.u0 = Opaque: Float: 100.000000 V/s
```

Change of community names / setting of passwords

For the communication with MPOD modules 4 types of SNMP communities are used, "public", "private", "admin" and "guru". By default the community names are equal to the community types.

```
snmpwalk -v 2c -m +WIENER-CRATE-MIB -c admin 192.168.0.81 snmpCommunityName
```

```
WIENER-CRATE-MIB::snmpCommunityName.public = STRING: "public"
```

```
WIENER-CRATE-MIB::snmpCommunityName.private = STRING: "private"
```

```
WIENER-CRATE-MIB::snmpCommunityName.admin = STRING: "admin"
```

```
snmpwalk -v 2c -m +WIENER-CRATE-MIB -c private 192.168.0.81 snmpCommunityName
```

```
WIENER-CRATE-MIB::snmpCommunityName.public = STRING: "public"
```

```
WIENER-CRATE-MIB::snmpCommunityName.private = STRING: "private"
```

In order to secure the MPOD system communication the community names can be used as passwords and be changed accordingly. The following example shows how the change and test the community names. Using a wrong community name will result in a time out error. Please note, that especially the communities with write access (private, admin) should be protected.

```
snmpset -v 2c -m +WIENER-CRATE-MIB -c private 192.168.0.81 snmpCommunityName.private seCrET
```

```
WIENER-CRATE-MIB::snmpCommunityName.private = STRING: "seCrET"
```

```
snmpwalk -v 2c -m +WIENER-CRATE-MIB -c private 192.168.0.81 snmpCommunityName
```

```
Timeout: No Response from 192.168.0.80
```

```
snmpwalk -v 2c -m +WIENER-CRATE-MIB -c seCrET 192.168.0.80 snmpCommunityName
```

```
WIENER-CRATE-MIB::snmpCommunityName.public = STRING: "public"
```

```
WIENER-CRATE-MIB::snmpCommunityName.private = STRING: ""seCrET"
```

```
WIENER-CRATE-MIB::snmpCommunityName.admin = STRING: "admin"
```

MIB Browser

There are several commercial or open source MIB-Browser programs available which can be used for SNMP communication. These provide often a simple GUI and allow SNMP calls.

Following is a list of some free or open source MIB – browsers:

<http://www.ireasoning.com/mibbrowser.shtml>

http://www.serverscheck.com/mib_browser/

<http://www.mibble.org/>

<http://www.ks-soft.net/hostmon.eng/mibbrowser/index.htm>

<http://www.tembria.com/products/snmpbrowser/index.html>

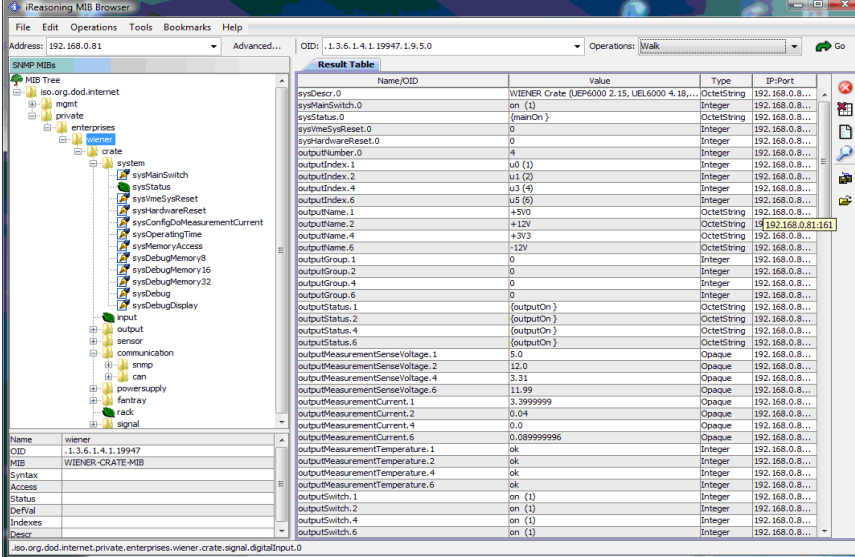

The screenshot shows the iReasoning MIB Browser interface. On the left is a tree view of MIB objects under the address 192.168.0.81. The tree is expanded to show the 'signal' object. The main window displays a 'Result Table' with the following data:

Name/OID	Value	Type	IP-Port
sysDescr.0	WIENER Crate (UEP6000 2.15, UEL6000 4.18...	OctetString	192.168.0.81:161
sysMainSwitch.0	on (1)	Integer	192.168.0.81:161
sysStatus.0	(mainOn)	OctetString	192.168.0.81:161
sysSysReset.0	0	Integer	192.168.0.81:161
sysHardwareReset.0	0	Integer	192.168.0.81:161
outputNumber.0	4	Integer	192.168.0.81:161
outputIndex.1	u0 (1)	Integer	192.168.0.81:161
outputIndex.2	u1 (2)	Integer	192.168.0.81:161
outputIndex.4	u3 (4)	Integer	192.168.0.81:161
outputIndex.6	u5 (6)	Integer	192.168.0.81:161
outputName.1	+5V0	OctetString	192.168.0.81:161
outputName.2	+12V	OctetString	192.168.0.81:161
outputName.4	+3V3	OctetString	192.168.0.81:161
outputName.6	-12V	OctetString	192.168.0.81:161
outputGroup.1	0	Integer	192.168.0.81:161
outputGroup.2	0	Integer	192.168.0.81:161
outputGroup.4	0	Integer	192.168.0.81:161
outputGroup.6	0	Integer	192.168.0.81:161
outputStatus.1	(outputOn)	OctetString	192.168.0.81:161
outputStatus.2	(outputOn)	OctetString	192.168.0.81:161
outputStatus.4	(outputOn)	OctetString	192.168.0.81:161
outputStatus.6	(outputOn)	OctetString	192.168.0.81:161
outputMeasurementSenseVoltage.1	5.0	Opaque	192.168.0.81:161
outputMeasurementSenseVoltage.2	12.0	Opaque	192.168.0.81:161
outputMeasurementSenseVoltage.4	3.31	Opaque	192.168.0.81:161
outputMeasurementSenseVoltage.6	11.99	Opaque	192.168.0.81:161
outputMeasurementCurrent.1	3.3999999	Opaque	192.168.0.81:161
outputMeasurementCurrent.2	0.04	Opaque	192.168.0.81:161
outputMeasurementCurrent.4	0.0	Opaque	192.168.0.81:161
outputMeasurementCurrent.6	0.089999996	Opaque	192.168.0.81:161
outputMeasurementTemperature.1	ok	Integer	192.168.0.81:161
outputMeasurementTemperature.2	ok	Integer	192.168.0.81:161
outputMeasurementTemperature.4	ok	Integer	192.168.0.81:161
outputMeasurementTemperature.6	ok	Integer	192.168.0.81:161
outputSwitch.1	on (1)	Integer	192.168.0.81:161
outputSwitch.2	on (1)	Integer	192.168.0.81:161
outputSwitch.4	on (1)	Integer	192.168.0.81:161
outputSwitch.6	on (1)	Integer	192.168.0.81:161

7 OPC Server

A server according to OPC Data Access V2.05 is optional available.

OPC (OLE for Process Control) allows fast and secure access to data and information under Windows operating systems. As an industry-spanning, multi-vendor software interface, OPC minimizes connection and maintenance overheads.

This server, running on a Computer with the Microsoft Windows XP operating system, enables access to all controllers which are connected to the network (TCP/IP). It is possible to

- access from any OPC Client application to the data of one or more servers
- encapsulating the properties specific to the server and type of communication
- commissioning support due to automatic scanning of the network and registration of communication stations
- restricting access rights by the underlying Microsoft DCOM.

The details of the OPC server can be found in the manual delivered with the OPC server software.

8 Power Bins PBN506/PBN512

For easy exchange of the PL512/PL506 Power Box the special bins PBN506/PBN512 are provided: The low voltage/high current cabling is connected to M5 threaded bolts (MULTICONACT). The arrangement is the same as at the power box: Starting from left with U0, and positive outputs up – negative outputs down.

Each sense lines of four output channels are connected to an eightfold pluggable terminal row.

If remote sensing is not used, the sense lines can be connected to the power outputs with jumpers.

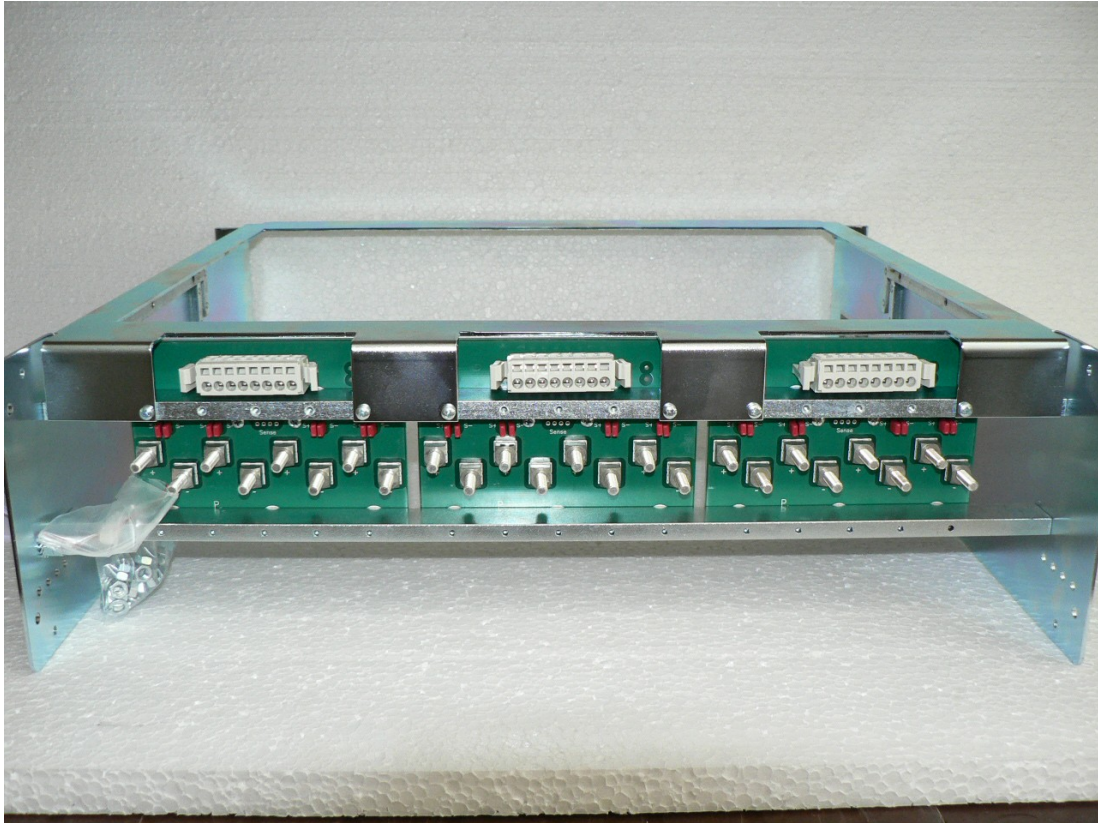

Figure 8.1: PBN512 -3U RATO Power Bin



Figure 8.2: PBN506 -3U RASO Power Bin (with PL506 Power Supply inserted)

DC Output Characteristics:

Sense compensation range:	Limited to < 10V or nominal voltage (whichever is lower).		
Regulation mode:	The voltage at the sense connection point is regulated.		
Floating range:	500 V test voltage		
Noise and ripple:	Voltage < 8 V	< 10 mV _{PP}	(0.5 m wire, 0–20 MHz)
	Voltage > 8 V	< 15 mV _{PP}	
		< 3 mV _{PP}	(10 m wire, 0-300 MHz)
		< 1.5 mV _{RMS}	
Conditions at the load:	Parallel (X) 330µF and 1µF ceramic, 100nF HF- conducting to case (Y) each line		
Emission:	CE EN 50081-1 (EN 55 022-B)		
Immunity:	CE EN 50082-1 or 2		
Operating temperature:	10 °C – 40 °C		
Storage Temperature:	- 30 °C - + 85 °C (cooling water must be completely removed, else +3 °C - +85 °C)		
Temp.- Coefficient:	< 0.2% / 10K		
Stability (constant conditions)	<5mV or 0.1% within 24 h, <25mV or 0.3% within 6 months		
Current limiting:	Programmable		
Status control / DC Off (trip off):	Tripping global, group- or channel wise programmable (after overload, overheat , overvoltage, undervoltage)		
Interlock input:	optional		
Efficiency (per Module):	65% 2V/ -81% >5V/ -85% >7V -87% >12V/ -90% >48V at nominal input voltage		
M T B F, cooled by:	Conditions: 3kW DC output with 80% efficiency (600W internal power dissipation: WORST CASE)		
Water, 30°C inflow:	ca. 120,000 h , put through > 50l/h for <10°C DT of cooling water. Minimum differential pressure >0.5 bar, abs. max. pressure <15 bar		
Forced Air, 30°C entrance:	ca. 90,000 h , put through > 153m3/h for <15°C DT of cooling air, ambient air pressure 1 bar. Adequate airflow is roughly 1,4m/s.		
	Values for air cooled units are valid for new ones. Abrasive dust, corrosion, etc. can limiting the heat transfer to the cooling air during lifetime. Higher operating temperature is the consequence.		
	Increasing of internal temperature at the most critical points of 10°C will reduce the MTBF by 50% Lower operating temperatures will increase the MTBF accordingly, independent of cooling medium.		
Communication	Ethernet 10/100M, USB 2		

Measurement Accuracy (typical values)

Voltage $\pm 0.1\%$ of the maximum output voltage of the channel

Current **MDC (single module)** $\pm 1\%$

MDC (paralleled) $\pm 1\%$

MDH $\pm 1\%$

Construction features, Accessories: 3 U box with extraction lever: max. 6 modules, up to 3 kW / 3,6kW output power

Connections / plugs: 24 female pins 80A, parallel used for higher currents, 3 x 9pin Sub D for sensing (each for 4 channels)

Dimensions (w, h, d) 434 mm x 132 mm x 325 mm

Weight: 31,5 kg

Accessories: 19" Power Bins PBN506/PBN512 for plug in PL506/PL512 power supplies power contacts with threaded bolts and sense terminals at rear side.

Types 4U x 450mm mounting depth, 1 U air baffle, strain relief, cooling air entry front- or bottom side, for 3U – Box
PBN506 -4U
PBN512 -4U :

Special power bins / 19" assembly with 3U and 6U (for two PL506/PL512 boxes) available. 450mm mounting depth

Appendix B: Ordering Information

Standard	0P11.xxxx
Special versions for CERN	0M11.xxxx

The left side of the ordering number is not descriptive, it is randomly assigned to the requested module & options configuration. Up to six power modules may be used inside of one power box.

The following modules are possible (external ventilation necessary):

Module Type	Channels per Module	Optimal Voltage Range	Peak Output Current	Continuous Output Power
MDC	2	2V ... 7V/8V	2*55A	2*300W
MDC	2	5/7V ... 15/16V	2*22A	2*300W
MDC	2	7V ... 24 V	2*11.5A	2*250W
MDC	2	30V ... 60V	2*6.6A	2*300W

The following modules can be used without external ventilation (integrated fans):

Module Type	Channels per Module	Optimal Voltage Range	Peak Output Current	Continuous Output Power
MDH	2	2V ... 7V/8V	2*30A	2*210W
MDH	2	5/7V ... 15/16V	2*20A	2*250W
MDH	2	7V...24V	11.5A	2*275W
MEH	1	2...7V	115A	550W
MEH	1	6...10V	80A	550W
MEH	1	7...16V	46A	550W
MEH	1	12...30V	23A	550W
MEH	1	30...60V	13.5A	550W

All power modules can be ordered with different sense regulation characteristics:

- Fast Fastest regulation, but may be instable if connected to cables longer than 1 m.
- Moderate This is the standard configuration for cable length up to 30 m
- Slow This is used for much longer cables

Available Power Bins:

	Ordering Number
Power Bin (MARA) 3U	0B15.1200
Power Bin (MARA) 6U, for two power boxes	0B14.2400

Appendix C: SNMP OID Tree

Only a small part of general SNMP OIDs is implemented. This is the tree view:

```
+--iso(1)
|
+--org(3)
|
+--dod(6)
|
+--internet(1)
|
+--directory(1)
|
+--mgmt(2)
| |
| +--mib-2(1)
| |
| | +--system(1)
| | |
| | | +-- -R-- String    sysDescr(1)
| | | |      Textual Convention: DisplayString
| | | |      Size: 0..255
| | | |
| | | | +-- -R-- ObjID   sysObjectID(2)
| | | | |
| | | | +-- -R-- TimeTicks sysUpTime(3)
| | | | |
| | | | +-- -RW- String    sysContact(4)
| | | | |      Textual Convention: DisplayString
| | | | |      Size: 0..255
| | | | |
| | | | +-- -RW- String    sysName(5)
| | | | |      Textual Convention: DisplayString
| | | | |      Size: 0..255
| | | | |
| | | | +-- -RW- String    sysLocation(6)
| | | | |      Textual Convention: DisplayString
| | | | |      Size: 0..255
| | | | |
| | | | +-- -R-- INTEGER  sysServices(7)
| | | | |      Range: 0..127
| | | | |
```

This is the tree view of the wiener-specific SNMP namespace. It could be generated with the command „snmptranslate -w 80 -Tp WIENER-CRATE-MIB::wiener“. Because it's a general definition, usable for different types of crates, some items may be not implemented in the real hardware. Here the not relevant parts are omitted.

The wiener OID is located at iso(1).org(3).dod(6).internet(1).private(4).enterprises(1).

A detailed description of the SNMP functionality can be found in the corresponding MIB file (WIENER-CRATE-MIB.txt)

```
+--crate(1)
|
+--system(1)
| |
| | +-- -RW- EnumVal    sysMainSwitch(1)
| | |      Values: OFF(0), ON(1)
| | +-- -R-- BitString sysStatus(2)
| | |      Values: mainOn(0), mainInhibit(1), localControlOnly(2),
| | |             inputFailure(3), outputFailure(4), fantrayFailure(5),
| | |             sensorFailure(6), VmeSysfail(7),
| | |             plugAndPlayIncompatible(8)
| | +-- -RW- EnumVal    sysVmeSysReset(3)
| | |      Values: TRIGGER(1)
| |
| +--input(2)
| |
| +--output(3)
| |
| | +-- -R-- INTEGER    outputNumber(1)
| | |      Range: 0..255
| | |
| | +--outputTable(2)
| | |
| | | +--outputEntry(1)
| | | |      Index: outputIndex
| | | |
| | | | +-- ---- EnumVal    outputIndex(1)
| | | | |      Values: U0(1), U1(2), U2(3), U3(4), U4(5), U5(6), U6(7),
| | | | |             U7(8), U8(9), U9(10), U10(11), U11(12)
| | | | |
| | | | +-- -R-- String    outputName(2)
```



```

|   | |
|   | +--snmpCommunityEntry(1)
|   | |   Index: snmpAccessRight
|   | |   |
|   | |   +--- ---- EnumVal   snmpAccessRight(1)
|   | |   |           Values: public(1), private(2), admin(3), guru(4)
|   | |   +--- -RW- String    snmpCommunityName(2)
|   | |           Size: 0..14
|   |
|   +--- -RW- INTEGER    snmpPort(2)
|
+--powersupply(6)
|
| +--- -R-- String      psSerialNumber(2)
| |           Textual Convention: DisplayString
| |           Size: 0..255
| +--- -R-- INTEGER    psOperatingTime(3)
| +--- -RW- String      psDirectAccess(1024)
|           Size: 1..14
|

```

Appendix D: Parallel Connection of Output Channels

A set of six current bars (4-fold) will be delivered by each power bin in a companion-assembly-pack.

How to use the current bars

If the power supply has channels with more than one contact pair, use the current bars to connect each option. For best operation it is necessary to connect the parallel outputs together as near as possible at the power supply site. For 200A (4-fold) the current bars can be used as they are, for 3-fold or dual paralleling they have to be cut accordingly.

4-fold : 200A (order number : 1480753.A1)

3-fold : 150A

2-fold : 100A

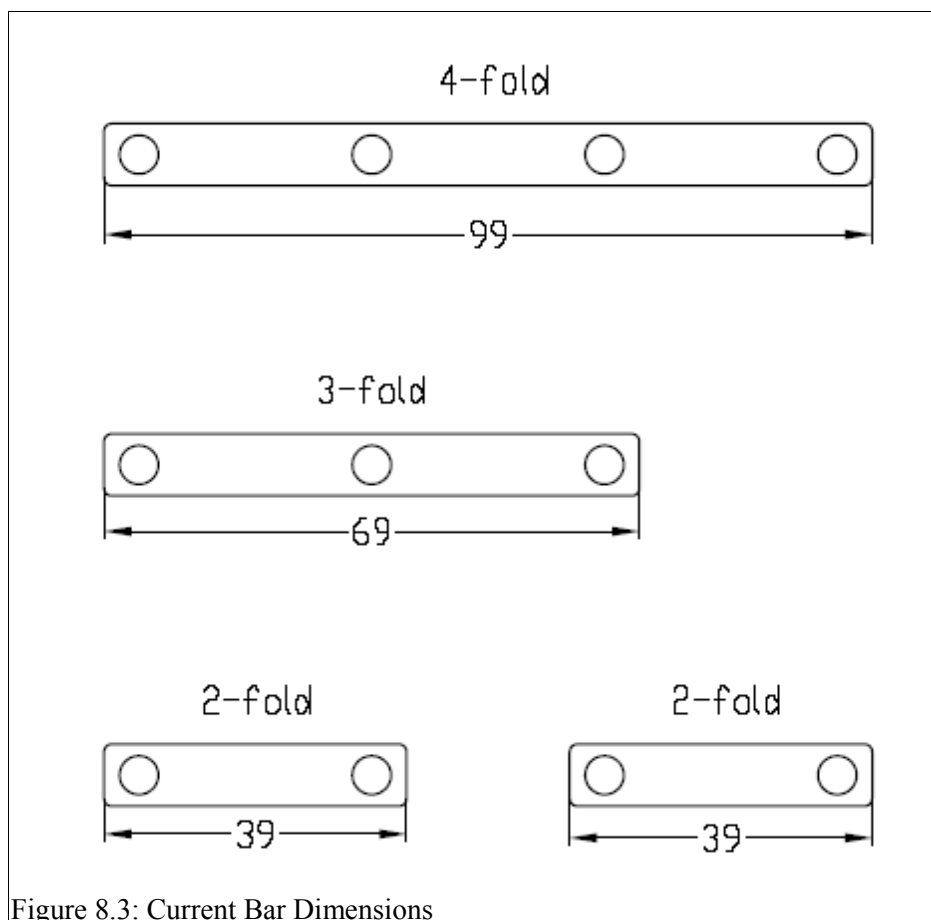

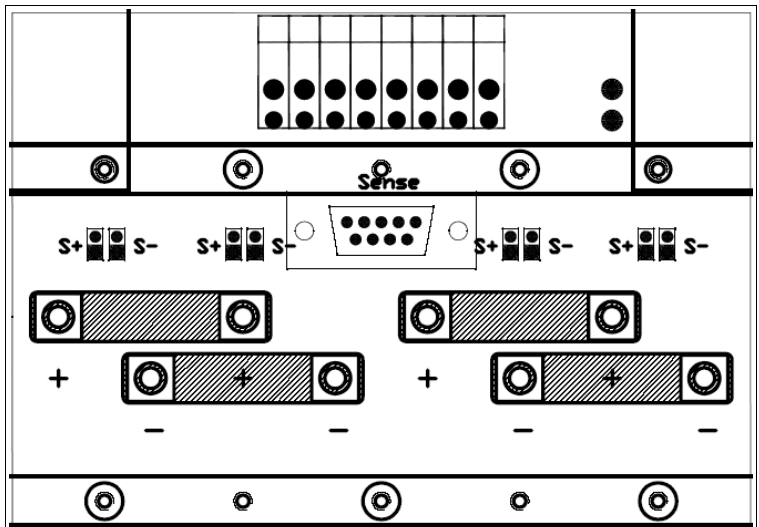

Figure 8.4: Two Channels Parallel

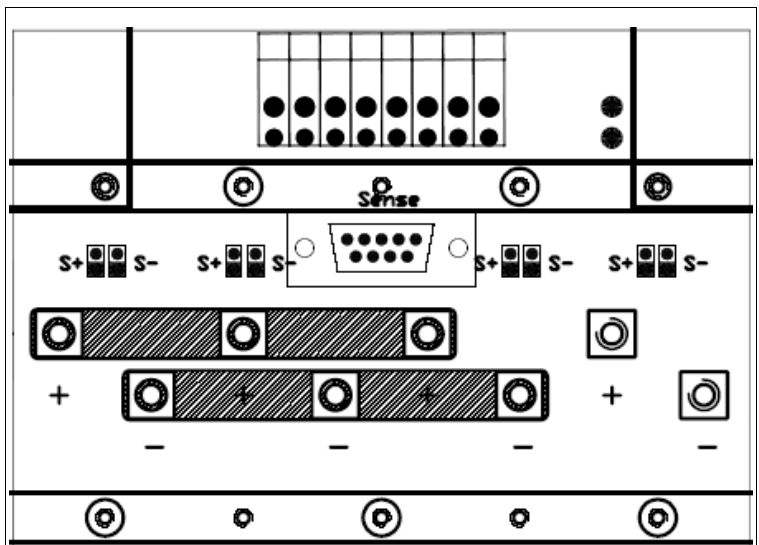

Figure 8.5: Three Channels Parallel

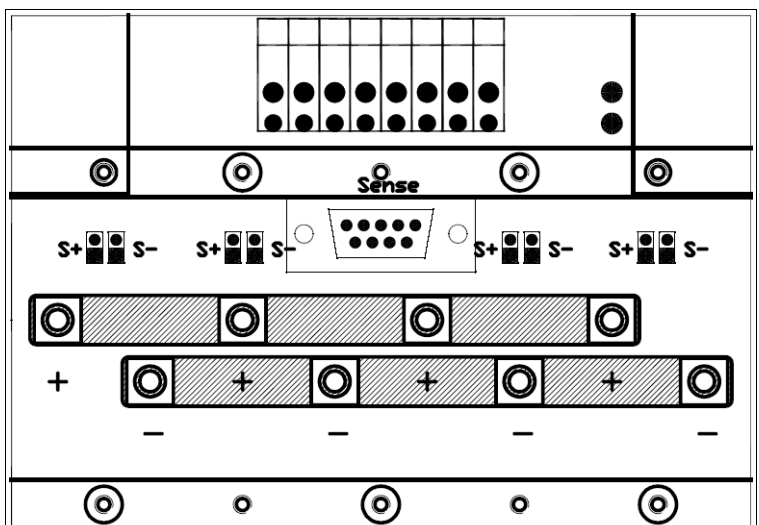

Figure 8.6: Four Channels Parallel